







## HOW TO ORDER

<b>ONLINE</b>	www.autoelectricsupplies.co.uk
<b>BY TELEPHONE</b>	01584 819552 (Monday to Thursday: 9am to 5pm, Friday: 9am - 3pm)
<b>BY POST</b>	Auto Electric Supplies Ltd Unit 2, Bright's Court, Tenbury Wells Business Park Bromyard Road, Tenbury Wells WR15 8FG
<b>BY EMAIL</b>	info@autoelectricsupplies.co.uk

## PAYMENT TYPES ACCEPTED

<b>CREDIT OR DEBIT CARD</b>	Please supply 16 digit number, expiry date and CVC
<b>PAYPAL</b>	accounts@autoelectricsupplies.co.uk
<b>BANK TRANSFER (£ Sterling):</b>	<p><b>Account Name:</b> Auto Electric Supplies Ltd  <b>Account No:</b> 13996719  <b>Sort Code:</b> 20-39-64  <b>IBAN:</b> GB82BUKB20396413996719  <b>SWIFTBIC:</b> BUKGB22</p> 
<b>(€ Euros):</b>	<p><b>Account Name:</b> Auto Electric Supplies Ltd  <b>Account No:</b> 43932166  <b>Sort Code:</b> 20-39-64  <b>IBAN:</b> GB72BUKB20396443932166  <b>SWIFTBIC:</b> BUKGB22</p> 

## DELIVERY CHARGES - UK MAINLAND

Service	Method	Parcel Value (before VAT)	Price
<b>STANDARD</b> (2-3 working days)	Goods will be despatched as soon as possible, subject to stock levels and cleared payment. The majority of packages will be despatched by post, but <b>heavier packages (over 1.25kg)</b> will be despatched by courier and <b>will require a signature on delivery.</b>	£0.01 - £20.00	<b>£3.75 + VAT</b>
		£20.01 - £100.00	<b>£4.80 + VAT</b>
		£100.01 and over	<b>FREE</b>
<b>COURIER</b> <i>NOT next working day</i>	Goods will be despatched as soon as possible, subject to stock levels and cleared payment. Packages are sent by courier and <b>will require a signature on delivery.</b> You will be emailed a tracking number upon despatch.	£Any Value	<b>£5.85 + VAT</b>
<b>NEXT WORKING DAY</b> (1 working day)	Goods <b>must be ordered before 1pm</b> for this service. Packages will be despatched on the same day as the order is placed, subject to stock levels and cleared payment. Packages are sent either by Royal Mail Special Delivery or by courier, and will require a signature on delivery. Although the vast majority of Next Working Day deliveries will arrive the next working day, please note that this service is not guaranteed and parcels are only despatched and delivered Monday to Friday and not on Saturdays.	£Any Value	<b>£7.50 + VAT</b>

## DELIVERY CHARGES - EVERYWHERE ELSE

Goods are despatched as soon as possible subject to stock levels and cleared payment. The chosen method of despatch is dependent on the weight and/or value of the goods ordered and will be the most cost effective available at the time.

Should you require a courier service or confirmation of delivery costs, please either contact us at info@autoelectricsupplies.co.uk or on 01584 819552. Alternatively, go to our website at www.autoelectricsupplies.co.uk- once you have filled your 'basket' with the goods you require, you will be presented with all available delivery options and costs.

# STANDARD PVC CABLE



General purpose low voltage cable for use in automotive and marine applications in temperatures up to 70°C. Consists of conductors of stranded copper wire which are PVC insulated.

Cable descriptions give the number and size of cable strands, the total cross-sectional area of conductor and the approximate outside diameter of the insulation. Eg. 14/0.30, 1.0mm<sup>2</sup> refers to 14 strands of 0.30mm diameter cable giving a total cable conductor area of 1.0mm<sup>2</sup> (see calculation method on p.5). Approximate OD is given as a rough guide only and is not to be used as a method by which to

decide which size cable is required.

Where two colours are indicated (eg. Blue/Black), the first is the main colour and the second is the tracer colour.

## 010101 - 5.75A - 0.65mm<sup>2</sup>

Capacity	Approx. Cable OD	Conductor Size	Conductor Area
5.75A	2.3mm	9/0.30	0.65mm <sup>2</sup>
Typical Uses: Side/Tail Lamps, Indicators			

Black (B)	Green (G)	Orange (T)	Red (R)
Blue (U)	Grey (S)	Pink (K)	White (W)
Brown (N)	Light Green (L)	Purple (P)	Yellow (Y)

## 010102 - 8.75A - 1.00mm<sup>2</sup>

Capacity	Approx. Cable OD	Conductor Size	Conductor Area
8.75A	2.6mm	14/0.30	1.0mm <sup>2</sup>
Typical Uses: Side/Tail Lamps, Indicators, Fog Lamps, General Wiring			

Black (B)	Brown (N)	Green/White (G/W)	Red/White (R/W)
Black/Blue (B/U)	Brown/Black (N/B)	Green/Yellow (G/Y)	Red/Yellow (R/Y)
Black/Green (B/G)	Brown/Green (N/G)	Grey (S)	White (W)
Black/Red (B/R)	Brown/Red (N/R)	Light Green (L)	White/Black (W/B)
Black/Yellow (B/Y)	Brown/White (N/W)	Orange (T)	White/Blue (W/U)
Blue (U)	Brown/Yellow (N/Y)	Pink (K)	White/Brown (W/N)
Blue/Black (U/B)	Green (G)	Purple (P)	White/Green (W/G)
Blue/Brown (U/N)	Green/Black (G/B)	Purple/Black (P/B)	White/Red (W/R)
Blue/Green (U/G)	Green/Blue (G/U)	Purple/White (P/W)	Yellow (Y)
Blue/Red (U/R)	Green/Brown (G/N)	Red (R)	Yellow/Black (Y/B)
Blue/White (U/W)	Green/Purple (G/P)	Red/Black (R/B)	Yellow/Blue (Y/U)
Blue/Yellow (U/Y)	Green/Red (G/R)	Red/Green (R/G)	Yellow/White (Y/W)

## 010103 - 17.5A - 2.0mm<sup>2</sup>

Capacity	Approx. Cable OD	Conductor Size	Conductor Area
17.5A	3.3mm	28/0.30	2.0mm <sup>2</sup>
Typical Uses: Headlamps, Wipers, Screen Heaters, Petrol Pumps, etc			

Black (B)	Brown (N)	Grey (S)	Red/Brown (R/N)
Black/Green (B/G)	Brown/Blue (N/U)	Light Green (L)	Red/White (R/W)
Black/Red (B/R)	Brown/Red (N/R)	Orange (T)	White (W)
Black/White (B/W)	Brown/White (N/W)	Pink (K)	White/Red (W/R)
Blue (U)	Brown/Yellow (N/Y)	Purple (P)	Yellow (Y)
Blue/Green (U/G)	Green (G)	Purple/White (P/W)	Yellow/Black (Y/B)
Blue/Orange (U/T)	Green/Black (G/B)	Purple/Yellow (P/Y)	Yellow/Brown (Y/N)
Blue/Red (U/R)	Green/Red (G/R)	Red (R)	Yellow/Red (Y/R)
Blue/White (U/W)	Green/White (G/W)	Red/Black (R/B)	Yellow/White (Y/W)
Blue/Yellow (U/Y)	Green/Yellow (G/Y)	Red/Blue (R/U)	

## 010104 - 27.5A - 3.0mm<sup>2</sup>

Capacity	Approx. Cable OD	Conductor Size	Conductor Area
27.5A	3.7mm	44/0.30	3.0mm <sup>2</sup>
Typical Uses: Charging Circuits, Main Feeds			

Black (B)	Brown (N)	Red (R)	
Blue (U)	Brown/Yellow (N/Y)	Yellow (Y)	

## 010105 - 35.0A - 4.5mm<sup>2</sup>

Capacity	Approx. Cable OD	Conductor Size	Conductor Area
35.0A	5.0mm	65/0.30	4.5mm <sup>2</sup>
Typical Uses: Heavy Duty Charging Circuits, Alternator Feeds			

Black (B)	Brown (N)	Red (R)	Yellow (Y)
-----------	-----------	---------	------------

## 010106 - 42.0A - 6.0mm<sup>2</sup>

Capacity	Approx. Cable OD	Conductor Size	Conductor Area
42.0A	5.7mm	84/0.30	6.0mm <sup>2</sup>
Typical Uses: Heavy Duty Charging Circuits, Alternator Feeds, Battery Feeds			

Black (B)	Brown (N)	Red (R)	
-----------	-----------	---------	--

## STANDARD PVC CABLE (contd)

### 010107 - 50.0A - 7.0mm<sup>2</sup>

Capacity	Approx. Cable OD	Conductor Size	Conductor Area
50.0A	6.2mm	97/0.30	7.0mm <sup>2</sup>
Typical Uses: Heavy Duty Charging Circuits, Alternator Feeds, Battery Feeds			

Black (B)	Brown (N)	Red (R)	
-----------	-----------	---------	--

### 010108 - 60.0A - 8.5mm<sup>2</sup>

Capacity	Approx. Cable OD	Conductor Size	Conductor Area
60.0A	7.0mm	120/0.30	8.5mm <sup>2</sup>
Typical Uses: Heavy Duty Charging Circuits, Alternator Feeds, Battery Feeds			

Black (B)	Brown (N)	Red (R)	
-----------	-----------	---------	--

### 010109 - 70.0A - 10.0mm<sup>2</sup>

Capacity	Approx. Cable OD	Conductor Size	Conductor Area
70.0A	7.5mm	80/0.40	10.0mm <sup>2</sup>
Typical Uses: Heavy Duty Charging Circuits, Alternator Feeds, Battery Feeds			

Black (B)	Red (R)		
-----------	---------	--	--

Part No.	Current (A)	m	30m roll	50m reel
010101	5.75	£0.38	-	£11.95
010102	8.75	£0.44	-	£16.22
010103	17.5	£0.63	-	£27.41
010104	27.5	£0.87	-	£37.65
010105	35.0	£1.25	£33.87	-
010106	42.0	£1.83	£49.21	-
010107	50.0	£2.17	£59.58	-
010108	60.0	£2.43	£65.63	-
010109	70.0	£2.77	£76.09	-

### PVC CABLE BUNDLE 1



A bundle of cable containing the following PVC cable in 10 different colours:

- 5 x 3m of 8.75A cable (010102)
- 3 x 3m of 17.5A cable (010103)
- 2 x 3m of 27.5A cable (010104)

Suitable for small wiring projects. (Colours may vary)

**160118**

**£14.53**

### PVC CABLE BUNDLE 2



A bundle of cable containing the following PVC cable in 13 different colours:

- 7 x 5m of 8.75A cable (010102)
- 4 x 5m of 17.5A cable (010103)
- 2 x 4m of 27.5A cable (010104)

Suitable for small to medium sized wiring projects. (Colours may vary)

**160119**

**£27.74**

#### HOW TO CALCULATE CABLE CONDUCTOR AREA:

Area =  $\pi r^2$ , where  $\pi$  = approx. 3.142 and r = radius

If the diameter of a strand of copper is 0.30mm, the radius is half of that, ie. 0.15mm

So, for a piece of cable with 120 strands of 0.30mm diameter the calculation would be:

$$(3.142 \times 0.15^2) \times 120 = 8.48\text{mm}^2$$

# THIN WALL CABLE



Thin wall low voltage cable, suitable for use in automotive and marine applications. Consists of conductors of stranded copper wire which are hard grade PVC insulated. Compared to standard PVC cable, the reduced insulation thickness and higher current capacity greatly reduces weight and volume. For these reasons, this cable is today used in preference to standard PVC cable by vehicle manufacturers.

Good resistance to petrol, diesel and abrasion. Suitable for use from -40°C to +105°C. Cable descriptions give number and size of cable strands and the total cross sectional area of the conductor. Where

two colours are indicated (eg. Blue/Black), the first is the main colour and the second is the tracer colour.

## 010710 - 7.0A - 0.35mm<sup>2</sup> (only available in 100m reels)

Capacity	Approx. Cable OD	Conductor Size	Conductor Area
7.0A	1.4mm	12/0.20	0.35mm <sup>2</sup>
Typical Uses: Instrument Wiring, Warning Lamps, Low Current Applications			

Black (B)	Green (G)	Orange (T)	Red (R)
Blue (U)	Grey (S)	Pink (K)	White (W)
Brown (N)	Light Green (L)	Purple (P)	Yellow (Y)

## 010701 - 11.0A - 0.5mm<sup>2</sup>

Capacity	Approx. Cable OD	Conductor Size	Conductor Area
11.0A	1.6mm	16/0.20	0.5mm <sup>2</sup>
Typical Uses: Instrument Wiring, Warning Lamps, Low Current Applications			

Black (B)	Green (G)	Pink (K)	White (W)
Blue (U)	Grey (S)	Purple (P)	Yellow (Y)
Brown (N)	Orange (T)	Red (R)	

## 010702 - 16.5A - 1.0mm<sup>2</sup>

Capacity	Approx. Cable OD	Conductor Size	Conductor Area
16.5A	2.0mm	32/0.20	1.0mm <sup>2</sup>
Typical Uses: Side/Tail Lamps, Indicators, Fog Lamps, Dashboard Wiring			

Black (B)	Black/Purple (B/P)	Blue/Black (U/B)	Blue/Yellow (U/Y)
Black/Blue (B/U)	Black/Red (B/R)	Blue/Orange (U/T)	Brown (N)
Black/Green (B/G)	Black/White (B/W)	Blue/Pink (U/K)	Brown/Black (N/B)
Black/Grey (B/S)	Black/Yellow (B/Y)	Blue/Red (U/R)	Brown/Green (N/G)
Black/Pink (B/K)	Blue (U)	Blue/White (U/W)	contd...

Brown/Red (N/R)	Grey (S)	Pink/Red (K/R)	Red/Green (R/G)
Brown/White (N/W)	Grey/Black (S/B)	Pink/White (K/W)	Red/White (R/W)
Brown/Yellow (N/Y)	Grey/Green (S/G)	Pink/Yellow (K/Y)	Red/Yellow (R/Y)
Green (G)	Grey/Orange (S/T)	Purple (P)	White (W)
Green/Black (G/B)	Grey/Red (S/R)	Purple/Black (P/B)	White/Brown (W/N)
Green/Blue (G/U)	Grey/White (S/W)	Purple/Brown (P/N)	White/Orange (W/T)
Green/Brown (G/N)	Grey/Yellow (S/Y)	Purple/Green (P/G)	Yellow (Y)
Green/Purple (G/P)	Light Green (L)	Purple/Yellow (P/Y)	Yellow/Black (Y/B)
Green/Red (G/R)	Orange (T)	Red (R)	Yellow/Brown (Y/N)
Green/White (G/W)	Pink (K)	Red/Black (R/B)	Yellow/Red (Y/R)
Green/Yellow (G/Y)	Pink/Black (K/B)	Red/Blue (R/U)	Yellow/White (Y/W)

## 010711 - 21.0A - 1.5mm<sup>2</sup>

Capacity	Approx. Cable OD	Conductor Size	Conductor Area
21.0A	2.3mm	21/0.30	1.5mm <sup>2</sup>
Typical Uses: Dashboard Wiring, Wipers, Lamps, etc			

Black (B)	Green (G)	Pink (K)	White (W)
Blue (U)	Grey (S)	Purple (P)	Yellow (Y)
Brown (N)	Orange (T)	Red (R)	

## 010703 - 25.0A - 2.0mm<sup>2</sup>

Capacity	Approx. Cable OD	Conductor Size	Conductor Area
25.0A	2.7mm	28/0.30	2.0mm <sup>2</sup>
Typical Uses: Headlamps, Wipers, Screen Heaters, Petrol Pumps			

Black (B)	Brown/Green (N/G)	Purple (P)	White/Brown (W/N)
Blue (U)	Brown/Red (N/R)	Red (R)	White/Orange (W/T)
Blue/Red (U/R)	Brown/White (N/W)	Red/Black (R/B)	Yellow (Y)
Blue/White (U/W)	Green (G)	Red/Blue (R/U)	Yellow/White (Y/W)
Blue/Yellow (U/Y)	Grey (S)	Red/Green (R/G)	
Brown (N)	Orange (T)	Red/Yellow (R/Y)	
Brown/Blue (N/U)	Pink (K)	White (W)	

contd...



## THIN WALL CABLE (contd)

### 010713 - 29.0A - 2.5mm<sup>2</sup>

Capacity	Approx. Cable OD	Conductor Size	Conductor Area
29.0A	2.75mm	35/0.30	2.5mm <sup>2</sup>
Typical Uses: Lamps, Charging Circuits, Additional Battery Circuits, etc			

Black (B)	Brown (N)	Grey (S)	White (W)
Blue (U)	Green (G)	Red (R)	Yellow (Y)

### 010704 - 33.0A - 3.0mm<sup>2</sup>

Capacity	Approx. Cable OD	Conductor Size	Conductor Area
33.0A	3.3mm	44/0.30	3.0mm <sup>2</sup>
Typical Uses: Charging Circuits, Main Feeds, Additional Battery Circuits, Dynamo Feeds			

Black (B)	Brown/Red (N/R)	Red (R)	White/Red (W/R)
Blue (U)	Green (G)	Red/Yellow (R/Y)	Yellow (Y)
Brown (N)	Grey (S)	White (W)	
Brown/Blue (N/U)	Orange (T)	White/Black (W/B)	
Brown/Green (N/G)	Purple (P)	White/Orange (W/T)	

### 010705 - 39.0A - 4.0mm<sup>2</sup>

Capacity	Approx. Cable OD	Conductor Size	Conductor Area
39.0A	3.7mm	56/0.30	4.0mm <sup>2</sup>
Typical Uses: Heavy Duty Charging Circuits, Alternator Feeds, Fuse Board Feeds			

Black (B)	Brown (N)	Red (R)	Yellow (Y)
-----------	-----------	---------	------------

### 010706 - 50.0A - 6.0mm<sup>2</sup>

Capacity	Approx. Cable OD	Conductor Size	Conductor Area
50.0A	4.3mm	84/0.30	6.0mm <sup>2</sup>
Typical Uses: Heavy Duty Charging Circuits, Alternator Feeds, Battery Feeds			

Black (B)	Brown (N)	Red (R)	Yellow (Y)
-----------	-----------	---------	------------

### 010707 - 63.0A - 8.5mm<sup>2</sup>

Capacity	Approx. Cable OD	Conductor Size	Conductor Area
63.0A	5.6mm	120/0.30	8.5mm <sup>2</sup>
Typical Uses: Heavy Duty Charging Circuits, Alternator Feeds, Battery Feeds			

Black (B)	Brown (N)	Red (R)	
-----------	-----------	---------	--

### 010708 - 70.0A - 10.0mm<sup>2</sup>

Capacity	Approx. Cable OD	Conductor Size	Conductor Area
70.0A	5.6mm	80/0.40	10.0mm <sup>2</sup>
Typical Uses: Heavy Duty Charging Circuits, Alternator Feeds, Battery Feeds			

Black (B)	Brown (N)	Red (R)	
-----------	-----------	---------	--

### 010714 - 110.0A - 16.0mm<sup>2</sup>

Capacity	Approx. Cable OD	Conductor Size	Conductor Area
110.0A	7.3mm	126/0.40	16.0mm <sup>2</sup>
Typical Uses: Heavy Duty Charging Circuits, Alternator Feeds, Battery Feeds			

Black (B)	Red (R)		
-----------	---------	--	--

Part No.	Current (A)	m	30m roll	100m reel
010710	7.0	-	-	£12.95
010701	11.0	£0.32	-	£14.51
010702	16.5	£0.41	-	£22.02
010711	21.0	£0.50	-	£32.67
010703	25.0	£0.60	-	£43.32
010713	29.0	£0.72	-	£56.64
010704	33.0	£0.84	£22.67	£69.95
010705	39.0	£1.18	£29.72	£89.15
010706	50.0	£1.66	£43.26	£129.72
010707	63.0	£2.31	£62.42	-
010708	70.0	£2.84	£76.43	-
010714	110.0	£4.54	£122.47	-

## THIN WALL CABLE BUNDLE



A bundle of cable containing ten 10m lengths of different colour 1mm<sup>2</sup> thinwall cable (010702). 100m in total.

**160122**

**£35.00**

### YOU MAY ALSO BE INTERESTED IN:

- Tinned copper thin wall cable- p.13
- Thin wall multicore cable- p.16

## BRAIDED CABLE - GENERAL PURPOSE



Braided cable is an authentic replacement cable for older vehicles such as classic and vintage cars. Manufactured by braiding modern PVC cable and then lacquering. The cable therefore looks like the original but has the electrical and mechanical properties of modern cable.

The colours listed below are stock colours. Any other colours are available subject to a minimum quantity of 30m. (Please call 01584 819552 or contact us by email).

When two colours are indicated (eg. Blue/Red), the first is the main colour and the second is the tracer. Herringbone pattern cable can also be supplied.

### 020101 - 8.75A - 1.0mm<sup>2</sup>

Capacity	Approx. Cable OD	Conductor Size	Conductor Area
8.75A	3.7mm	14/0.30	1.0mm <sup>2</sup>
Typical Uses: Side/Tail lamps, Indicators, Fog Lamps, General Wiring			

Black (B)	Green (G)	Purple (P)
Black/White (B/W)	Green/Black (G/B)	Purple/Black (P/B)
Black/White H-Bone (B/W-H)	Green/Purple (G/P)	Red (R)
Black/Yellow H-Bone (B/Y-H)	Green/Red (G/R)	Red/Black H-Bone (R/B-H)
Blue (U)	Green/White (G/W)	White (W)
Blue/Red (U/R)	Grey (S)	White/Black (W/B)
Blue/White (U/W)	Orange (T)	Yellow (Y)
Blue/Yellow (U/Y)	Orange/2 Black (Alfa) (T/2B)	Yellow/Green (Y/G)
Brown (N)	Pink (K)	

### 020110 - 13.0A - 1.5mm<sup>2</sup>

Capacity	Approx. Cable OD	Conductor Size	Conductor Area
13.0A	4.0mm	21/0.30	1.5mm <sup>2</sup>
Typical Uses: Auxilliary circuits, Headlights, Fuel Pumps, etc			

Black (B) only

### 020102 - 17.5A - 2.0mm<sup>2</sup>

Capacity	Approx. Cable OD	Conductor Size	Conductor Area
17.5A	4.2mm	28/0.30	2.0mm <sup>2</sup>
Typical Uses: Headlamps, Wipers, Screen Heaters, Petrol Pumps, etc			

Black (B)      Blue (U)      contd....

Blue/Red (U/R)	Green/Black (G/B)	Red/Black (R/B)
Blue/White (U/W)	Grey (S)	Red/Black H-Bone (R/B-H)
Blue/White H-Bone (U/W-H)	Orange (T)	White (W)
Blue/Yellow (U/Y)	Orange/2 Black (Alfa) (T/2B)	White/Black (W/B)
Brown (N)	Pink (K)	White/Black H-Bone (W/B-H)
Brown/Blue (N/U)	Purple (P)	Yellow (Y)
Brown/White (N/W)	Purple/Black (P/B)	
Green (G)	Red (R)	

### 020103 - 27.5A - 3.0mm<sup>2</sup>

Capacity	Approx. Cable OD	Conductor Size	Conductor Area
27.5A	4.8mm	44/0.30	3.0mm <sup>2</sup>
Typical Uses: Charging Circuits, Main Feeds			

Black (B)	Green (G)	Red/Black H-Bone (R/B-H)
Blue (U)	Grey (S)	White (W)
Blue/White H-Bone (U/W-H)	Orange (T)	White/Red (W/R)
Brown (N)	Orange/2 Black (Alfa) (T/2B)	Yellow (Y)
Brown/Blue (N/U)	Purple (P)	Yellow/Black (Y/B)
Brown/White (N/W)	Red (R)	

### 020105 - 35.0A - 4.5mm<sup>2</sup>

Capacity	Approx. Cable OD	Conductor Size	Conductor Area
35.0A	5.9mm	65/0.30	4.5mm <sup>2</sup>
Typical Uses: Heavy Duty Charging Circuits, Alternator Feeds			

Black (B)	Orange/2 Black (Alfa) (T/2B)	Yellow (Y)
Brown (N)	Red (R)	
Orange (T)	Red/2 Black (R/2B)	

### 020707 - 63.0A - 8.5mm<sup>2</sup>

Capacity	Approx. Cable OD	Conductor Size	Conductor Area
63.0A	6.5mm	120/0.30	8.5mm <sup>2</sup>
Typical Uses: Heavy Duty Charging Circuits, Alternator Feeds, Battery Feeds			

Black (B)      Brown (N)      Red (R)



## BRAIDED CABLE - GENERAL PURPOSE (contd)

Part No.	Current (A)	m	30m roll	50m roll
020101	8.75	£1.02	-	£45.77
020102	17.5	£1.28	-	£56.88
020103	27.5	£1.69	-	£77.31
020105	35.0	£2.45	£68.59	-
020707	63.0	£3.21	£91.43	

## BRAIDED CABLE BUNDLE



A bundle of cable containing the following braided cable in different colours:

- 8 x 3m of 8.75A cable (020101) (Black, Red, Blue, Green, Yellow, Brown, White, Purple)
- 4 x 3m of 17.5A cable (020102) (Black, Red, Green, Blue)
- 2 x 3m of 27.5A cable (020103) (Red, Black)

Suitable for small wiring projects.

**160133**      **£42.78**

### YOU MAY ALSO BE INTERESTED IN:

- Braided multicore cable - p.15
- Braided HT cable - p.19
- Braided battery cable - p.21



## TINNED COPPER THIN WALL CABLE



This cable is as per standard thin wall cable except the copper conductors are tin plated, making them more suitable for marine and other corrosive environments.

- Tinned copper conductors - PVC insulated
- Hard grade PVC insulation offers good resistance to abrasion and cut through
- For use at temperatures between -40 to 105°C, with excursions to 120°C
- Reduced insulation thickness gives savings in weight and volume
- Good resistance to petrol, diesel, oil and diluted acid
- Suitable for 12V and 24V systems (60V max)
- Manufactured in accordance with ISO6722:2006 (class B)

### 010901 - 21.0A - 1.5mm<sup>2</sup>

Capacity	Approx. Cable OD	Conductor Size	Conductor Area
21.0A	2.4mm	21/0.30	1.5mm <sup>2</sup>

Black (B)	Brown (N)	Red (R)	
Blue (U)	Green (G)	Yellow (Y)	

### 010902 - 29.0A - 2.5mm<sup>2</sup>

Capacity	Approx. Cable OD	Conductor Size	Conductor Area
29.0A	3.0mm	35/0.30	2.5mm <sup>2</sup>

Black (B)	Brown (N)	Red (R)	
Blue (U)	Green (G)	Yellow (Y)	

### 010903 - 39.0A - 4.0mm<sup>2</sup>

Capacity	Approx. Cable OD	Conductor Size	Conductor Area
39.0A	3.7mm	56/0.30	4.0mm <sup>2</sup>

Black (B)	Brown (N)	Green (G)	Red (R)
-----------	-----------	-----------	---------

### 010904 - 50.0A - 6.0mm<sup>2</sup>

Capacity	Approx. Cable OD	Conductor Size	Conductor Area
50.0A	4.3mm	56/0.30	6.0mm <sup>2</sup>

Black (B)	Green (G)	Red (R)	
-----------	-----------	---------	--

contd...

## TINNED COPPER THIN WALL CABLE (contd)

### 010905 - 70.0A - 10.0mm<sup>2</sup>

Capacity	Approx. Cable OD	Conductor Size	Conductor Area
70.0A	2.4mm	21/0.30	10.0mm <sup>2</sup>

Black (B)	Green (G)	Red (R)	
-----------	-----------	---------	--

Part No.	Current (A)	m	30m roll	50m roll
010901	21.0	£0.63	-	£24.97
010902	29.0	£0.91	-	£36.61
010903	39.0	£1.37	£35.39	-
010904	50.0	£1.83	£49.06	-
010905	70.0	£2.96	£83.10	-

## MULTICORE CABLE - TINNED

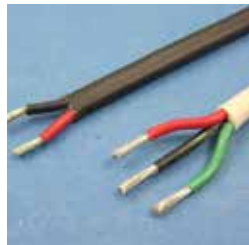

Ocean Flex® multicore cables are high temperature, thin wall low voltage wiring cables. Ocean Flex® is designed for use in marine, automotive and harsh environments. The core copper strands are tin plated, making the cable more resistant to corrosion. Available with either black or white outer sheathing (21A cables).

Cores manufactured to ISO 6722-1:2011 (Class B) 105°C. Tinned copper conductors - PVC sheathed 70°C.

Part No.	Cable Size	Current (A)	Outer Colour	m	30m reel
010950-B	2 x 21/0.30	21.0	Black	£1.31	£35.56
010950-W	2 x 21/0.30	21.0	White	£1.31	£35.56
010952-B	3 x 21/0.30	21.0	Black	£1.74	£46.80
010952-W	3 x 21/0.30	21.0	White	£1.74	£46.80
010953	3 x 35/0.30	29.0	Black	£2.54	£62.99
010959	5 x 35/0.30	29.0	Black	£4.02	-
010960	7 x 21/0.30	21.0	Black	£4.10	£115.36

## MULTICORE CABLE - PVC

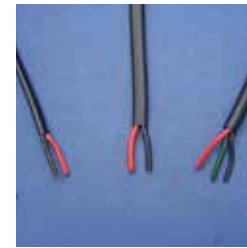

Consists of PVC insulated single conductors sheathed in black PVC outer.

#### PLEASE NOTE:

010206 has a low current capacity and is suitable for applications such as tank senders, etc.

#### YOU MAY ALSO BE INTERESTED IN:

- Trailer Cable - p.16

Part No.	Cable Size	Current (A)	m	25m reel	30m reel	100m reel
010201	2 x 9/0.30	5.75	£0.78	-	£18.53	-
010202	2 x 14/0.30	8.75	£0.83	-	£19.55	£59.44
010203	2 x 28/0.30	17.5	£1.23	-	£29.57	-
010204	3 x 14/0.30	8.75	£1.18	-	£32.11	-
010206	4 x 16/0.20	2.5	£2.17	£49.04	-	-
010213	4 x 14/0.30	8.75	£1.58		£40.41	-

## MULTICORE CABLE - BRAIDED

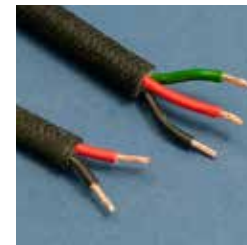

PVC insulated single conductors sheathed in black PVC outer, braided in black cotton and lacquered.

Part No.	Cable Size	Current (A)	m	10m roll
020301	2 x 9/0.30	5.75	£2.82	£22.54
020302	2 x 14/0.30	8.75	£2.98	£23.78
020303	2 x 28/0.30	17.5	£3.37	£26.83
020304	3 x 14/0.30	8.75	£3.39	£28.77

## MULTICORE CABLE - THIN WALL



Thin wall low voltage cable, suitable for use in automotive applications. Consists of conductors of stranded copper wire which are hard grade PVC insulated. Compared to standard PVC cable, the reduced insulation thickness and higher current capacity greatly reduces weight and volume. For these reasons, this cable is today used in preference to standard PVC cable by vehicle manufacturers.

Good resistance to petrol, diesel and abrasion. Suitable for use from -40°C to +105°C. Cable descriptions give number and size of cable strands and the total cross sectional area of the conductor.

**010209 core colours:** 8 x 21A: Y, U, G, N, B, R, K, W/U and 5 x 29A: S, W, T, W/B, W/T  
**010210 core colours:** 9 x 16.5A: B, R, G, S, U, Y, N, T, P and 1 x 25A: W

Part No.	Cable Size	Current (A)	m	30m reel	100m reel
010721	2 x 16/0.20	11.0	£0.58	£15.07	£41.28
010723	2 x 32/0.20	16.5	£0.86	£20.60	£61.76
010724	2 x 21/0.30	21.0	£1.13	£27.54	£80.84
010725	2 x 28/0.30	25.0	£1.41	£34.47	£100.59
010727	2 x 44/0.30	33.0	£2.26	£53.98	£161.82
010728	2 x 65/0.30	42.0	£3.27	£79.84	£234.11
010732	3 x 32/0.20	16.5	£1.54	£37.77	£108.54
010742	4 x 32/0.20	16.5	£1.74	£40.74	£123.44
010752	5 x 32/0.20	16.5	£2.08	£48.79	£147.81
010209-CH	8 x 21/0.30 + 5 x 35/0.30	21/29	£7.34	-	-
010210	9 x 32/0.20 + 1 x 28/0.30	16.5/25	£5.25	-	-

## MULTICORE CABLE - TRAILER CABLE



Two sizes available, consisting of 7 insulated single conductors sheathed in black PVC.

**010301** - current capacity 7 x 5.75A, suitable for smaller applications

**010302** - current capacity 6 x 8.75A and 1 x 17.5A, suitable for larger jobs.

Part No.	Cable Size	Current (A)	m	30m reel
010301	7 x 9/0.30	5.75	£1.77	£42.48
010302	6 x 14/0.30 + 1 x 28/0.30	8.75/17.5	£2.42	£58.02

## SPEAKER CABLE

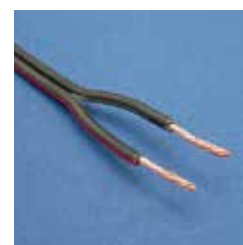

Two flat, figure of eight cables, suitable for wiring speakers either in vehicles or buildings. Available in 3 different sizes, 3A, 6A & 10A.

Part No.	Cable Size	Current (A)	m	30m reel
011101	2 x 16/0.20	3.0	£0.44	£11.77
011102	2 x 24/0.20	6.0	£0.60	£16.05
011103	2 x 32/0.20	10.0	£0.76	£20.69

## HT CABLE - STANDARD PVC



PVC ignition cable. 21 x 0.30mm diameter copper conductors (1.5mm<sup>2</sup>). Available as standard 7mm OD, or narrower 6mm OD.

010403 available in black only.

Part No.	Cable Colour	OD (mm)	m	30m reel	100m reel
010401-B	Black	7.0	£1.03	£24.24	£72.70
010401-R	Red	7.0	£1.03	£24.24	£72.70
010403	Black	6.0	£0.89	£18.96	-

### YOU MAY ALSO BE INTERESTED IN:

- Heat Shrink HT Cable Markers - p.27

## HT CABLE - SILICONE RUBBER/COPPER CORE



**010402:** Silicone HT cable, with tinned copper conductors. 7mm diameter. 35kV minimum breakdown voltage, -30°C to 155°C. This cable is more flexible than standard PVC HT cable and capable of withstanding higher temperatures. The tinned copper conductors also offer enhanced corrosion resistance. White silicone core.

**010407:** Specification as above except 5mm diameter and 25kV breakdown voltage. Useful in applications where space is at a premium.



**010402-B-4:** 800mm long HT cable with soldered on spark plug terminals and heat shrink markers. Simply cut to length and connect to the distributor or magneto. Supplied as a kit of 4 (marked 1-4).

Part No.	Cable Colour	OD (mm)	Each	m	25m reel	100m reel
010402-B	Black	7.0	-	£2.11	£44.71	£168.30
010402-R	Red	7.0	-	£2.31	£49.16	£180.95
010402-B-4	Black	7.0	£18.52	-	-	-
010407	Black	5.0	-	£1.85	£49.93	£147.96

## HT CABLE - SILICONE RUBBER/RESISTIVE CORE



**010405:** Ignition cable with a resistive core for use where suppression is required. The cable can be terminated by folding the conductor beneath the terminal. Overall diameter 7mm. 35kV minimum breakdown voltage, -30°C to 155°C. Colours available: Black and yellow.

**010406:** 5mm diameter ignition cable with carbon resistive core, for use where suppression is required. 25kV breakdown voltage, -40°C to 220°C. Useful in applications where space is at a premium.

Part No.	Cable Colour	OD (mm)	m	25m reel	30m reel	100m reel
010405	Black	7.0	£2.01	£42.61	-	-
010405-Y	Yellow	7.0	-	-	-	£155.67
010406	Red	5.0	£2.00	-	£53.50	£158.52

## HT CABLE - BRAIDED



**020401:** Copper cored braided HT cable, PVC insulated, **available in colours listed below** (other colours can be made on request- please call 01584 819552). 7mm OD.

Black (B)	Red (R)	Yellow/Black (Y/B)
Black/Red (B/R)	Red/Black (R/B)	
Green/Red (G/R)	Red/Yellow (R/Y)	



**020401-4 and 020401-1:** 800mm long braided HT cable(s) with soldered on spark plug terminal(s). Simply cut to length and connect to the coil or magneto. 020401-4 is a set of four leads, and 020401-1 is one lead only. 7mm OD. Available in the following colours:

Yellow/Black (Y/B)	Black/Red (B/R)	Red/Black (R/B)
Red/Yellow (R/Y)	Green/Red (G/R)	



**020407-Y/R:** 6mm OD braided HT cable. This is only really used when space is at a premium, for example where all the HT cables pass down a conduit together. Colour is yellow with red tracer.

Part No.	OD (mm)	Each	m	25m roll
020401	7.0	-	£3.09	£69.43
020401-4	7.0	£18.52	-	-
020401-1	7.0	£5.21	-	-
020407-Y/R	6.0	-	£3.01	£66.68

### YOU MAY ALSO BE INTERESTED IN:

- Clear Heat Shrink Tubing (110304-C). If a wipe clean cable is required, this can be slid over the cable once cut to length and then shrunk using a hot air gun. This then adds a gloss clear waterproof covering to the cable. See p.23.

## BATTERY CABLE - FLEXIBLE



Flexible battery cable has many finer strands than the semi-rigid type. Consequently, it is far more flexible. Cable descriptions give number and size of cable strands, the total cross-sectional area of the conductor, the outside diameter and the current rating. For example, 322/0.30, 25mm<sup>2</sup>, 10mm, 170A indicates that the cable has 322 x 0.3mm diameter strands of copper, giving a cross sectional area of 25mm<sup>2</sup>, the outside diameter of the cable, including the insulation, is 10.0mm and the current rating is 170A.

Available in either **black (-B)** or **red (-R)**.

### PLEASE NOTE:

\* 010607 95mm<sup>2</sup> cable is only ordered on request and will take a little longer to despatch.

Part No.	Conductor Size	Conductor Area (mm <sup>2</sup> )	OD (mm)	Capacity (A)	m	10m reel
010604	206/0.30	16	8.2	110	£4.17	£38.63
010601	266/0.30	20	8.9	135	£4.77	£42.80
010602	322/0.30	25	10.0	170	£6.21	£55.87
010603	539/0.30	40	12.7	300	£9.30	£83.81
010605	805/0.30	60	14.6	415	£14.60	£131.36
010607 *	684/0.40	95	19.7	500	-	£185.57

## BATTERY CABLE - SEMI-RIGID



Semi-rigid battery cable. Older type, and fairly inflexible.

Cable descriptions give number and size of cable strands and the total cross-sectional area of the conductor. For example, 37/0.71, 15mm<sup>2</sup>, 8.0mm indicates that the cable has 37 x 0.71mm wide strands of copper, giving a cross sectional area of 15mm<sup>2</sup>, and the total diameter of the cable, including the insulation, is 8.0mm.

Available in either **black (-B)** or **red (-R)**.

Part No.	Conductor Size	Conductor Area (mm <sup>2</sup> )	OD (mm)	Capacity (A)	m	10m reel
010502	37/0.90	25	9.7	170	£7.06	£63.48
010503	61/0.90	40	11.8	300	£10.31	£92.72

## BATTERY CABLE - BRAIDED



As per general cable, braided battery cable is modern PVC flexible battery cable that has been braided in cotton and lacquered. Available in either **black (-B)** or **red (-R)**.

Part No.	Conductor Size	Conductor Area (mm <sup>2</sup> )	OD (mm)	Capacity (A)	m	10m reel
020201	206/0.30	16	8.0	105	£7.18	£65.29
020202	196/0.40	25	9.7	170	£9.07	£81.73
020203	315/0.40	40	11.8	300	£11.28	£101.35

## BATTERY CABLE - TINNED



This battery cable is very similar to flexible battery cable except that the copper conductors are tin plated, making them more suitable for marine and other corrosive environments.

Single insulated, extra flexible battery cables, designed for use in tough environments. Resistant to petrol, oils and diluted acids. Tinned copper conductors, PVC insulated with a working temperature of between -30°C and 70°C.

Cable details are given below. For example, 011001, has 203 strands of 0.3mm diameter tinned copper wire (203/0.3), has a conductor cross sectional area of 16mm<sup>2</sup>, a capacity of 110 Amps and its diameter including insulation is 8.3mm.

Available in either **black (-B)** or **red (-R)**.

Part No.	Conductor Size	Conductor Area (mm <sup>2</sup> )	OD (mm)	Capacity (A)	m	10m reel
011001	203/0.30	16	8.3	110	£4.78	£42.90
011002	322/0.30	25	10.1	170	£7.12	£64.09
011003	455/0.30	35	11.8	240	£9.95	£89.55
011004	637/0.30	50	13.3	345	£14.04	£126.02
011005	912/0.30	70	15.5	485	£19.67	£176.97
011006	648/0.40	95	17.9	500	£26.16	£235.28



## PVC SLEEVING

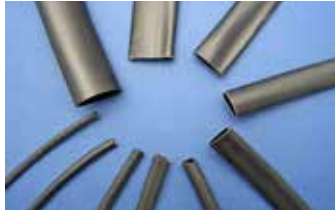

General purpose black PVC sleeving for bundling and protection of cables. Water, oil and petrol resistant. Operating temperature -20°C to +70°C.

Part No.	Internal Diameter (mm)	Wall Thickness (mm)	m	25m
110201	4	0.5	£0.34	£5.34
110202	5	0.5	£0.44	£6.67
110203	6	0.5	£0.48	£7.49
110204	8	0.5	£0.55	£8.89
110205	10	0.5	£0.64	£12.43
110206	12	0.5	£0.87	£18.27
110207	14	0.5	£1.03	£21.99
110208	16	0.5	£1.20	£25.62
110209	20	0.5	£1.38	£29.34
110210	25	1.0	£1.63	£34.43

### PVC SLEEVING SELECTION PACK



1m each of 110201 to 110208.

**110211**      **£5.33**

## HEAT SHRINK SLEEVING

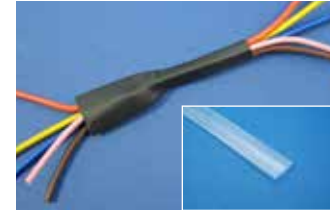

Commercial grade polyolefin heat shrink tubing. Available in **black** or **red** (or **clear** 110304-C). Operating temperature -55°C to +125°C. Shrink ratio of 2:1. Can be shrunk using a standard hot air gun.

Main picture shows heat shrink tubing after heating on right hand side.

Part No.	Colour	Int. Dia. before heating (mm)	Int. Dia. after heating (mm)	m	5m
110301	Black or Red	3.2	1.6	£0.88	£3.72
110302	Black or Red	4.8	2.4	£1.07	£4.54
110303	Black or Red	6.4	3.2	£1.37	£5.80
110304	Black or Red	9.6	4.8	£1.50	£6.39
110304-C	Clear	9.6	4.8	£1.50	-
110305	Black or Red	12.8	6.4	£1.85	£7.86
110306	Black or Red	19.0	9.5	£2.91	£12.41
110307	Black only	25.4	12.7	£3.79	£16.05
110308	Black only	38.2	19.1	£9.23	£39.18

### HEAT SHRINK SELECTION PACK



1m each of 110301- 110306. Available in either **red (-R)** or **black (-B)**.

**110309**      **£8.22**

### HEAT SHRINK KIT



74 pieces of heatshrink sleeving, in 5 different colours (yellow, red, blue, black and white), 7 different diameters (2.4, 3.2, 4.8, 6.4, 9.5, 12.7 & 19mm- prior to shrinking) and two different lengths (70 & 200mm). Supplied in a plastic case with dividers. Heatshrink has a shrink ratio of 2:1, so will halve its diameter on heating.

**160117**      **£22.18**



## SPIRAL BINDING



An easy and quick way of bundling and protecting cables. It also has the advantage that it can be put on cables whilst in situ. Made from low density polyethylene with an operating temperature range of -60°C to +50°C.

110102 is also available in a clear version: 110102-C.

Part No.	Colour	Dia. (mm)	Wall Thick. (mm)	Bundle Dia. (mm)	m	25m
110103	Black	3	0.75	1.5- 7.0	£0.43	£8.22
110101	Black	6	1.0	5- 20	£0.66	£13.43
110102	Black	12	1.5	10- 40	£1.12	£22.40
110102-C	Clear	12	1.5	10- 40	£1.12	£22.40

## NEOPRENE SLEEVES



Used for insulating and finishing non-insulated terminals. Sleeves are pre-lubricated and applied using special application tool (150102 - p.237).

Sleeve colour is black. Operating temperature range -65°C to +90°C. Sold in bags of 100.

Part No.	Length (mm)	Wall Thick. (mm)	Bore Dia. (mm)	Max. Cable Dia. (mm)	100
110506	20	0.75	1.5	3	£4.17
110507	20	0.75	2.0	4	£4.45
110508	20	0.75	3.0	6	£4.57
110509	25	1.0	5.0	10	£7.70
110510	25	1.25	7.5	15	£10.34

### YOU MAY ALSO BE INTERESTED IN:

- Neoprene Sleeve Application Tool - p.237

## CONVOLUTED SLEEVING



Black polyamide unslit convoluted sleeving for bundling and protection of wiring. Operating temp. -40°C to +120°C. Self extinguishing. Petrol, oil and water resistant.

Part No.	Int. Dia. (mm)	Ext. Dia. (mm)	m	10m	100m
110401	6.5	10.0	£0.76	£7.28	£55.57
110406	10.0	13.0	£0.99	£8.97	£62.52
110402	12.7	16.1	£1.20	£10.94	£83.35
110403	16.7	21.2	£1.24	£11.28	£103.03
110407	21.4	25.4	£1.34	£12.17	£109.50
110408	27.9	34.5	£1.95	£17.88	£167.85

## CONDUIT SUPERSEAL INTERFACES



Perfect for connecting the waterproof Superseal connectors (p.67) with our convoluted sleeving, this helps to protect the cable from dirt and other types of ingress. Provides a professional finish to your wiring and the 90° version allows the conduit to rotate 360° around the connector housing. This can minimise problems due to movement or vibration.

Suitable for connecting to 10mm and 13mm OD sleeving.

Part No.	Superseal Connector	Type	Convoluted Sleeving OD (mm)	Each	10
050652	2	Straight	10	£1.25	£11.29
050652-90	2	90°	10	£1.69	£15.23
050653	3	Straight	10	£1.31	£11.77
050653-90	3	90°	10	£2.03	£18.21
050654	4	Straight	10	£1.42	£12.85
050672	2	Straight	13	£1.25	£11.29
050672-90	2	90°	13	£2.24	£20.19
050673	3	Straight	13	£1.31	£11.71
050674	4	Straight	13	£1.38	£12.34

## EXPANDABLE BRAIDED SLEEVING



Made from black polyester which, because of its woven construction, expands readily to fit a range of cable bundle diameters. Cables can also be routed out through the sleeving wall. It has very good abrasion resistance, and has a temperature range of -70°C to +150°C. To stop fraying, the cut end should be fused using a soldering iron, or covered using heatshrink sleeving (p.23) or neoprene sleeves (p.24).

Part No.	Min. Dia. (mm)	Max. Dia. (mm)	m	10m
110701	3	7	£0.93	£8.28
110702	5	10	£1.29	£11.53
110703	10	18	£2.24	£20.09
110704	15	27	£2.40	£21.58

## TEMPERATURE RESISTANT SLEEVING



Temperature resistant sleeving, used for the protection of cables. Made from braided glass fibre, coated in black acrylic resin. The sleeving has excellent flexibility and strength. Temperature resistant to 155°C continuous use, 200°C short term use.

Available in 8 different sizes.

Part No.	Int. Dia. (mm)	m	10m
110802	2	£0.95	£8.46
110803	4	£1.67	£14.90
110804	6	£2.33	£20.95
110805	8	£2.96	£26.72
110806	10	£3.65	£32.92
110809	12	£3.95	£35.52
110807	14	£4.33	£38.91
110808	16	£4.77	£42.80

## CABLE MARKERS - CLIP-ON



Available in 3 sizes in handy packs. Useful for marking cable after termination as markers are simply clipped on the side of the cable. Packs contain equal numbers of 0, 1, 2, 3, 4, 5, 6, 7, 8 & 9. Each number is a different colour.

Part No.	Cable OD (mm)	Pack Contents	Each
110902	2.0- 2.8	20 x "0" - "9"	£12.73
110903	2.8- 3.8	20 x "0" - "9"	£12.94
110904	4.3- 5.3	10 x "0" - "9"	£16.00

## CABLE MARKERS - HEAT SHRINK



Manufactured from white heat-shrink with black text. Shrink ratio of 3:1 when heated above 120°C.

Sold either in bags of 100 (each bag having 10 of 0, 1, 2, 3, 4, 5, 6, 7, 8, & 9), or in smaller packs specifically for HT cables, containing 1 each of numbers 1 - 4 or 1 - 6.

Part No.	Pack Contents	Initial Dia. (mm)	After Heating Dia. (mm)	Each
110901	10 x "0" - "9"	6	2	£9.69
060901	10 x "0" - "9"	12	4	£11.19
060902	1 x "1" - "4"	12	4	£0.68
060903	1 x "1" - "6"	12	4	£1.03

## CABLE MARKERS - SLIDE-ON



Made from coloured PVC. Designed for easy fitting without tools. Fit cables from 2-5mm in diameter. 500 markers per pack, approximately 50 each of 0, 1, 2, 3, 4, 5, 6, 7, 8 & 9.

Part No.	Cable OD (mm)	Pack Contents	Each
110905	2.0- 5.0	50 x "0" - "9"	£12.71

## BUCKLE CLIPS

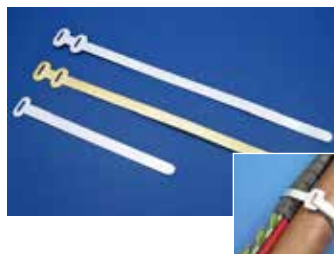

Useful for securing looms and cables where a period look is preferred. Made from aluminium or brass.

121802 and 121804 have a double end fixing (as shown in the picture).

Part No.	Size (mm)	Material	Single/ Double Fix.	Each	10
121801	102 x 6.3	Aluminium	Single	£0.34	£3.10
121803	142 x 6.3	Aluminium	Single	£0.44	£3.93
121805	178 x 6.3	Aluminium	Single	£0.51	£4.77
121802	178 x 6.3	Aluminium	Double	£0.74	£6.67
121804	178 x 6.3	Brass	Double	£1.18	£10.71

## CABLE TIES - BLACK NYLON



Made from black nylon in a range of sizes.

Part No.	Length (mm)	Width (mm)	10	100
120801	102	2.5	£0.36	£1.03
120804	150	3.6	£0.43	£2.16
120802	165	2.5	£0.44	£2.17
120806	190	4.8	£0.68	£3.45
120803	200	2.5	£0.50	£2.52
120809	240	7.6	£1.46	£8.34
120805	292	3.6	£1.02	£5.43
120807	368	4.8	£1.08	£7.23
120810	380	7.6	£2.87	£14.32
120808	450	4.8	£2.17	£14.45

## CABLE TIES - WHITE NYLON



Made from white nylon with a useful marker plate.

Part No.	Length (mm)	Width (mm)	10	100
120901	100	2.5	£1.32	£6.64

## CABLE TIE KITS



Spectrum cable tie kits, supplied in handy plastic tubes.

The smaller kit (120820) contains 250 cable ties in three different sizes: 100 red (100 x 2.5mm), 100 yellow (150 x 2.5mm) and 50 white (200 x 3.6mm).

The larger kit (120821) contains 1200 cable ties in 6 different colours (black, red, white, green, blue and yellow) and 4 different sizes: 500 (100 x 2.5mm), 200 (150 x 3.6mm), 400 (200 x 4.5mm) and 100 (300 x 4.5mm).

Part No.	No. of Cable Ties	Each
120820	250	£6.65
120821	1200	£28.56

## VELCRO CABLE TIES



200mm long velcro ties, suitable for cable fixing and management.

Simple to adjust and reusable, approx 13mm wide.

Part No.	Size (mm)	10	25
120902	200 x 13	£8.44	£18.96

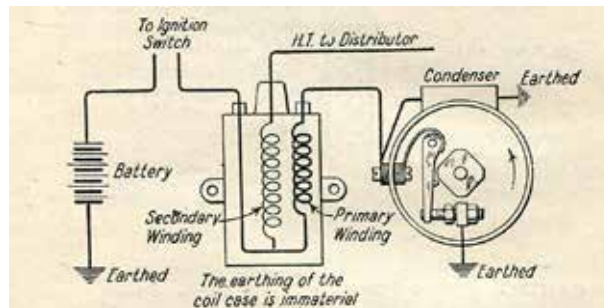

## CABLE TIE MOUNTS - EYELETS



Made from black nylon. Type A mounts have a central fixing hole, whilst Type B's is offset.



Type A



Type B

Part No.	Max. cable tie width (mm)	Type	10	25
121003	4.8	A	£1.20	£2.59
121004	9.0	A	£1.55	£3.27
121005	4.8	B	£1.20	£2.59

## CABLE TIE MOUNTS - SELF-ADHESIVE



Self adhesive mounts available in two different sizes. Made from black plastic. The 28 x 28mm mount also has a central fixing hole.

Part No.	Max. cable tie width (mm)	Mount Size (mm)	Each	25
121001	3.2	21 x 21	£0.25	£2.75
121002	4.8	28 x 28	£0.28	£5.64



## P-CLIPS - BRASS



Part No.	Int. Dia. (mm)	Fixing Hole Dia. (mm)	Each	10
120401	5	3.2	£0.49	£4.12
120401-L	5	5.0	£0.49	£4.12
120407	6	5.0	£0.60	£5.06
120408	8	5.0	£0.66	£5.61
120402	10	4.2	£0.72	£6.32
120403	15	5.0	£0.71	£6.16
120404	20	6.4	£0.74	£6.44
120405	22	5.0	£1.02	£8.65
120406	25	5.0	£1.53	£12.89

## BRASS P-CLIP KIT



Contains a selection of 80 brass P-Clips, ranging in size from 5mm to 22mm. Packed in a robust plastic case with dividers.

160113

£52.03

## P-CLIPS - ALUMINIUM (RUBBER COVERED)

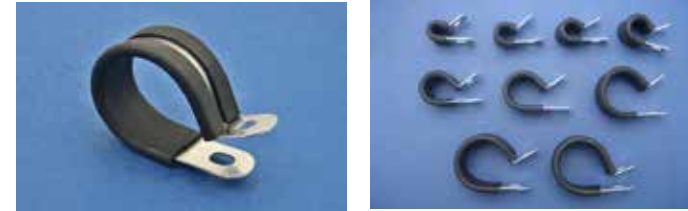

Part No.	Int. Dia. (mm)	Fixing Hole Dia. (mm)	Each	10
120201	4.8	5.2	£1.07	£9.00
120202	6.4	5.2	£1.12	£9.51
120203	7.9	5.2	£1.13	£9.65
120204	9.5	5.2	£1.18	£10.15
120205	12.7	5.2	£1.38	£11.67
120206	15.9	5.2	£1.47	£12.44
120207	19.1	5.2	£1.66	£13.95
120208	22.2	5.2	£1.79	£15.24
120209	25.4	5.2	£1.87	£16.01

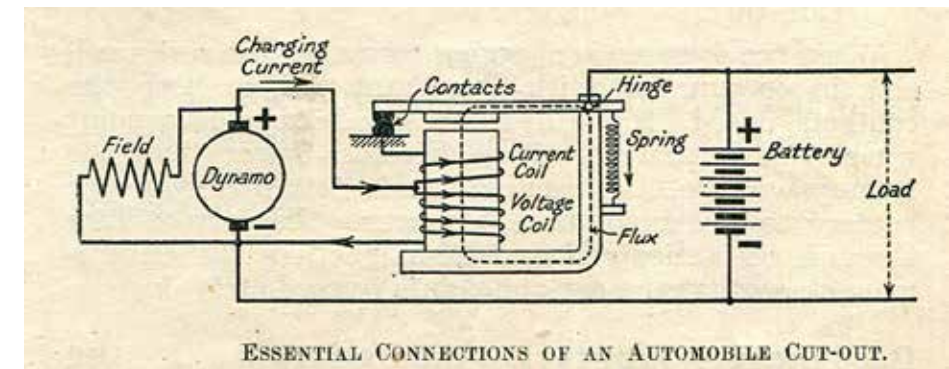



## P-CLIPS - STEEL (RUBBER COVERED)



Part No.	Int. Dia. (mm)	Fixing Hole Dia. (mm)	Each	10
120301	3.2	6.8	£0.32	£2.80
120302	4.8	6.8	£0.36	£3.09
120303	6.4	6.8	£0.38	£3.23
120304	7.9	6.8	£0.39	£3.38
120305	9.5	6.8	£0.41	£3.51
120306	12.7	6.8	£0.51	£4.41
120307	15.9	6.8	£0.57	£4.83
120308	19.0	6.8	£0.68	£5.86
120309	22.2	6.8	£0.72	£6.32
120310	25.4	6.8	£0.80	£6.75

### STEEL P-CLIP KIT



Contains a selection of 95 rubber-lined steel p-clips ranging in size from 6.4mm to 25.4mm. Packed into a robust plastic case with dividers.

**160116**      **£49.26**

## P-CLIPS - BLACK NYLON



Part No.	Int. Dia. (mm)	Fixing Hole Dia. (mm)	10	50
120101	3.2	4.6	£0.66	£2.87
120102	4.8	4.6	£0.68	£2.93
120103	6.4	4.6	£0.72	£3.16
120104	7.9	4.6	£0.82	£3.45
120105	9.5	4.6	£0.87	£3.66
120106	12.7	4.6	£1.07	£4.55
120107	15.8	4.6	£1.23	£5.29
120108	19.4	4.6	£1.63	£6.95
120109	25.4	4.6	£1.87	£7.97
120110	31.8	4.6	£2.22	£9.46

### NYLON P-CLIP KIT



Contains a selection of 240 nylon P-clips ranging in size from 3.2mm to 19.4mm. Packed into a robust plastic case with dividers.

**160114**      **£22.75**

### NYLON P-CLIP KIT REFILL



Refill option without box, containing a selection of 240 nylon P-clips ranging in size from 3.2mm to 19.4mm.

**160114-RF**      **£17.85**



## CHASSIS CLIPS - CLIP-ON (LARGE)



120501



120502



120503



120504



120505

Plated steel, 12.7mm wide, except 120505, which is 8mm wide. Simply clip on to chassis.

Part No.	Length (mm)	Max. Cable Dia. (mm)	Each	10
120501	66	6.5	£1.06	£8.97
120502	56	5.5	£0.69	£6.03
120503	41	5.5	£0.76	£6.59
120504	40	6.5	£0.69	£6.03
120505	30	10.0	£0.57	£4.83

## CHASSIS CLIPS - CLIP-ON (SMALL)



Plated steel. Simply clip on to chassis. Available for two chassis thicknesses.

Part No.	Chassis Thickness (mm)	Max. Cable Dia. (mm)	Each	10
120506	2 - 4	6 - 7	£0.68	£5.86
120507	2 - 4	8 - 9	£0.69	£6.05
120508	2 - 4	10 - 11	£0.69	£6.05
120509	2 - 4	12 - 14	£0.72	£6.32
120510	4 - 7	6 - 7	£0.68	£5.86
120511	4 - 7	8 - 9	£0.69	£6.03
120512	4 - 7	10 - 11	£0.69	£6.03
120513	4 - 7	12 - 14	£0.72	£6.32

## CHASSIS CLIPS - BOLT-ON



Plated steel with a hole to bolt on to chassis.

Part No.	Max. Cable OD (mm)	Fixing Hole Dia. (mm)	10	25
120601	4	5	£4.07	£7.19
120602	5	5	£4.07	£7.19
120603	8	5	£4.07	£7.19
120604	10	5	£4.07	£7.19
120605	12	6	£4.07	£7.19
120606	16	6	£4.07	£7.19

## SADDLE CLIPS



Zinc plated saddle clips. 10 mm wide.

121901, 121903 & 121904 all have 4.8mm dia. mounting holes, 121902 has 4mm.

Part No.	Max. Cable OD (mm)	Mounting Hole Centres (mm)	Each	10
121903	5.0	19	£0.26	£2.10
121901	6.0	20	£0.26	£2.10
121904	7.0	22	£0.27	£2.22
121902	2 x 6.0	28	£0.30	£2.59

## CHASSIS CLIPS - SELF- ADHESIVE (NYLON)

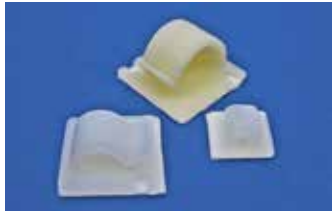

Nylon cable mounting clips with a self adhesive base. Suitable for fixing round or flat cables. Natural colour nylon.

Part No.	Max. Cable OD (mm)	Base Size (mm)	Each	10
120701	3.8	16 x 16	£0.27	£2.21
120702	7.7	25 x 25	£0.32	£2.80
120703	12.0	28 x 28	£0.38	£3.23

## CHASSIS CLIPS - SELF-ADHESIVE (ALUMINIUM)



Aluminium self adhesive cable mounting clips. Two sizes available.



Part No.	Max. Cable OD (mm)	Base Size (mm)	10	25
120704	6.0	11 x 16	£1.48	£3.11
120705	9.5	16 x 19	£2.11	£4.43

## WIRING GROMMETS



Black PVC, slot width 1.6mm.

Part No.	Panel Hole Size (mm)	Grommet OD (mm)	Grommet ID (mm)	Each	10	25
121101	6.4	9.5	4.0	-	£0.63	£1.09
121102	7.9	11.0	5.5	-	£0.76	£1.53
121103	9.3	13.4	7.7	-	£0.79	£1.40
121104	12.3	16.2	9.5	-	£1.02	£1.80
121105	15.8	19.0	12.0	-	£1.40	£2.59
121106	20.2	23.0	15.8	-	£2.43	£4.45
121107	25.0	29.2	19.5	-	£2.67	£5.32
121108	31.0	38.1	24.0	£0.39	£2.75	-
121109	37.4	46.0	31.5	£0.76	£4.88	-
121110	50.5	60.3	44.5	£0.89	£6.86	-

## WIRING GROMMET KIT



Contains a selection of 180 wiring grommets (for panel hole sizes from 6.4mm to 25.2mm) packed into a robust plastic case with dividers.

160104

£29.01

## WIRING GROMMET KIT REFILL



Refill option without box, containing a selection of 180 wiring grommets (for panel hole sizes from 6.4mm to 25.2mm).

160104-RF

£24.15

## BLANKING GROMMETS



Black PVC, slot width 1.6mm.

Part No.	Panel Hole Size (mm)	Grommet OD (mm)	Each	10	25
121201	6.4	8.5	-	£0.96	£1.87
121202	9.3	13.4	-	£1.13	£2.13
121203	12.3	16.2	-	£1.32	£2.33
121204	15.8	19.0	-	£1.56	£2.80
121205	20.0	24.2	-	£2.18	£3.81
121206	25.0	29.2	-	£2.58	£4.46
121207	31.7	38.1	£0.49	£3.10	-
121208	37.7	44.4	£0.80	£5.49	-
121209	50.5	57.2	£1.28	£8.91	-

## BLANKING GROMMET KIT



Contains a selection of 180 blanking grommets (for panel hole sizes from 6.4mm to 22.5mm) packed into a robust plastic case with dividers.

**160105**      **£29.01**

## GROMMET STRIP - NATURAL

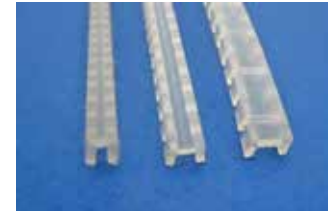

Ideal for irregular shaped openings. Made from natural coloured polythene. Available for three different panel thicknesses.

Part No.	Panel Thickness (mm)	m	5m
121111	1.0 - 1.3	£1.09	£5.16
121112	1.3 - 2.1	£1.23	£5.79
121113	2.1 - 3.3	£1.28	£6.00

## GROMMET STRIP - BLACK



Grommet strip made from black PVC, which has excellent flexibility, a temperature range from -65°C to 105°C and is self extinguishing. Suitable for panel thicknesses from 1 - 1.6mm.

Part No.	Panel Thickness (mm)	m	5m
121114	1.0 - 1.6	£1.23	£5.79

## PVC INSULATING TAPE



Self adhesive PVC tape. Temp. range 0°C to +70°C. Thickness 0.13mm.

Part No.	Colour	Each	10
121301	Black	£1.28	£11.25
121302	Red	£1.28	£11.25
121303	Green	£1.28	£11.25
121304	Blue	£1.28	£11.25
121305	Yellow	£1.28	£11.25
121306	Brown	£1.28	£11.25
121307	White	£1.28	£11.25

## PVC HARNESS TAPE



Non adhesive PVC tape used for wrapping wiring looms to protect against abrasion, etc. Flame retardant. Operating temp. 0°C to +90°C. Thickness 0.13mm. Available in **black**.

NOTE: 121401-40 is a 40m long roll.

Part No.	Width (mm)	Length (m)	Each	10
121401-40	19	40	£3.30	£29.61
121402	25	20	£2.75	£23.45

## CLOTH INSULATING TAPE



An old-style electrical tape useful for insulation and harness wrapping. Black cotton with a natural rubber adhesive. 19mm x 20m long. 0.35mm thick.

Part No.	Width (mm)	Length (m)	Each
121601	19	20	£6.64

## FABRIC LOOMING TAPE



Self adhesive black fabric tape for wrapping wiring harnesses. As used today by some vehicle manufacturers for wrapping wiring looms. Available in two widths, 25m long.

Part No.	Width (mm)	Length (m)	Each
121701	9	25	£3.44
121702	19	25	£8.13

## POLYESTER LOOM TAPE



Polyester looming tape. This is a lightweight modern version of the fabric looming tape 121702.

25m roll by 19mm wide. 0.25mm thick and has a temperature range of -40°C to 150°C.

This is what you find under the bonnet of your modern car, wrapping various bits of wiring!

Part No.	Width (mm)	Length (m)	Each
121705	19	25	£5.23

## SELF-AMALGAMATING TAPE

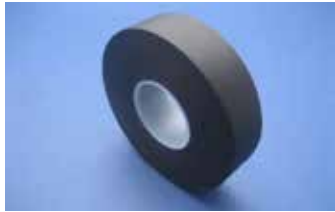

Strong self amalgamating polyisobutylene elastic tape which, when wrapped onto itself, will amalgamate creating a water-tight seal. Operating temp. -95°C to +90°C. Thickness 0.5mm. 25mm wide, 10m long.

Part No.	Width (mm)	Length (m)	Each
121501	25	10	£11.20

## RHINO TAPE

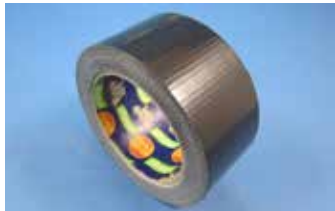

Rugged, super strong, waterproof cloth tape made in the UK. Bonds to glass, wood, fabric, underlay, polythene, damp proof membrane, stone, tarpaulin, polypropylene, tiles, ceramics, etc.

Works well in low temperatures.

Each roll is 50mm wide x 20m long.

Part No.	Width (mm)	Length (m)	Each
121706	50	20	£6.03

## X-TREME TAPE



Self-fusing silicone insulating and repair tape. Withstands extremes in voltage, temperature, pressure, moisture and fuels. Available in **black** or **red**.

Part No.	Width (mm)	Length (m)	Colour	Each
121704-B	25	3	Black	£5.29
121704-R	25	3	Red	£5.29

## NON-INSULATED TERMINALS - MALE BLADE



Male blade terminals to fit into female blade terminals. First dimension is blade width, second is cable size.

Made from either tin-plated brass, or plain brass.

Part No.	Width (mm)	Cable Size (mm <sup>2</sup> )	25	50
030100	2.8	0.5- 1.5	£1.74	£3.27
030101	4.8	0.3- 0.8	£2.40	£3.83
030102	6.3	1.0- 2.5	£2.92	£4.12

## NON-INSULATED TERMINALS - PIGGY-BACK



Made from brass.

Part No.	Width (mm)	Cable Size (mm <sup>2</sup> )	25	50
030402	6.3	1.5- 2.5	£4.22	£6.71

## RIVET-ON EARTH TERMINAL



Earth connection with 2 x 6.3mm brass blades and pop rivet.

Requires a 4.8mm diameter hole and can be fixed to material up to 4mm thick.

Rivet head is made from copper and the mandrel from copper plated steel. The underside of the brass plate has small spikes to ensure good conductivity.

Part No.	Width (mm)	Each
030110	2 x 6.3	£8.49

## NON-INSULATED TERMINALS - FEMALE BLADE



Female blade terminals to fit male blades (found on switches, components etc). Made from either tin-plated brass, or plain brass.

Part No.	Width (mm)	Cable Size (mm <sup>2</sup> )	10	25	50
030201	2.8	0.3 - 0.8	-	£2.06	£3.30
030202	4.8	0.5 - 1.3	-	£2.52	£3.98
030203	6.3	0.5 - 1.5	-	£2.35	£3.68
030204	6.3	1.0 - 2.5	-	£2.47	£3.87
030205	6.3	2.5 - 6.0	-	£2.55	£4.03
030206	9.5	2.0 - 4.0	£1.76	-	£7.02

## INSULATION SLEEVES FOR FEMALE BLADES



Part No.	Width (mm)	Colour	Type	10	25	50
030500	2.8	Clear	Flexible	-	£1.89	£3.39
030501	4.8	Clear	Flexible	-	£2.13	£3.34
030502	6.3	Black	Rigid	-	£3.59	£5.67
030503	6.3	Clear	Flexible	-	£2.01	£3.21
030506	9.5	Clear	Flexible	£2.02	-	£8.01

## FEMALE BLADE WITH TAG



6.3mm female blade terminals, that have a catch that locks onto the male blade when pushed onto one.

The female blade will only release from the male blade when the small 'button' is pushed down.



Part No.	Width (mm)	Cable Size (mm <sup>2</sup> )	10	50
030208	6.3	2.5 - 6.0	£1.89	£8.51
030209	6.3	0.5 - 2.0	£1.80	£8.09

## NON-INSULATED TERMINALS - FLAG



Three sizes available. To fit either 6.3, 8.0 & 9.5mm blades. PVC covers available for the 6.3mm only.

The 8mm flags (030303) have a tag and are suitable for headlamp connectors 050502 (p.177).

Use tool 150215 (p.234) to crimp the 6.3mm flag.

Made from either tin-plated brass, or plain brass.

Part No.	Width (mm)	Cable Size (mm <sup>2</sup> )	10	25	50
030301	6.3	1.0 - 2.5	-	£3.34	£5.33
030303	8.0	1.5 - 2.5	£2.58	-	£10.32
030302	9.5	3.0 - 6.0	£6.47	-	£27.49

## INSULATION SLEEVES FOR FLAGS



Made from vinyl PVC.

Part No.	Width (mm)	Colour	Type	25	50
030601	6.3	Clear	Flexible	£1.92	£3.09



## CABLE EYELETS



Cable eyelets that can be used to create an old style ring connector. Similar to Ross Courtney connectors that were used on Rolls Royces and Bentleys.

Part No.	Hole Dia. (mm)	Max. Cable Size (mm <sup>2</sup> )	10	50
031501	4.0	2.0	£1.64	£7.35
031502	5.0	3.0	£1.64	£7.35
031503	6.0	2.0	£1.76	£7.93
031504	8.0	2.0	£2.02	£9.05

## BLADE TERMINALS WITH TAGS



Male and female blade terminals with tags to fit multiple connector housings and many types of relay bases etc.

Made from either tin-plated brass, or plain brass.

Part No.	Male/Female	Size (mm)	Cable Size (mm <sup>2</sup> )	Each	10	50
050209	Male	2.8	0.5 - 1.5	£0.09	£0.61	£2.89
050205	Female	2.8	0.5 - 1.5	£0.09	£0.61	£2.89
050208	Female	4.8	0.5 - 1.0	£0.21	£1.79	£8.02
050201	Male	6.3	1.0 - 2.5	£0.09	£0.61	£2.89
050203	Female	6.3	1.0 - 2.5	£0.09	£0.61	£2.89
050202	Male	6.3	2.5 - 6.0	£0.20	£1.32	£6.27
050204	Female	6.3	2.5 - 6.0	£0.20	£1.32	£6.27
050207	Female	8.0	1.0 - 2.5	£0.30	£2.64	£12.56
050206	Female	9.5	2.0 - 6.0	£0.43	£3.30	£14.83

## BOLT-ON BLADES AND ADAPTER



030107 converts one male 6.3mm blade to two.

Part No.	Size (mm)	Mount. hole dia. (mm)	Type	25	50
030103	6.3	5.3	Straight	£4.22	£6.71
030104	6.3	5.3	45°	£4.14	£6.58
030105	6.3	5.3	90°	£4.36	£6.89
030107	6.3	-	Adapter	£4.57	£7.27

## NON-INSULATED TERMINALS - FORK



Part No.	Slot Width (mm)	Cable Size (mm <sup>2</sup> )	25	50
030901	4.3	0.5 - 1.5	£2.18	£3.51
030902	5.2	0.5 - 1.5	£2.35	£3.75
030903	3.8	1.0 - 2.5	£2.86	£4.54
030904	5.2	1.0 - 2.5	£2.86	£4.54

## SPARE TERMINAL FOR FUSE SOCKET



Pack of 10 spare terminals for use with 140305 (relay socket with three fuses) - see p.137.

**031401**  
£1.58 / 10

## NON-INSULATED TERMINALS - RING



General purpose ring terminals made from tin-plated brass.

Part No.	Hole Dia. (mm)	Imperial	Cable Size (mm <sup>2</sup> )	25	50
030701	3.2	4BA	0.5 - 1.5	£2.04	£3.23
030702	4.3	3BA	0.5 - 1.5	£2.04	£3.26
030703	5.3	2BA	0.5 - 1.5	£2.04	£3.26
030704	6.4	¼"	0.5 - 1.5	£2.65	£4.18
030705	8.3	⅜"	0.5 - 1.5	£2.80	£4.64
030706	10.4	⅝"	0.5 - 1.5	£3.56	£5.75
030707	3.2	4BA	1.0 - 2.5	£2.52	£3.86
030708	4.3	3BA	1.0 - 2.5	£2.59	£4.16
030709	5.3	2BA	1.0 - 2.5	£2.71	£4.33
030710	6.4	¼"	1.0 - 2.5	£2.65	£4.70
030711	8.3	⅜"	1.0 - 2.5	£3.01	£4.79
030712	10.4	⅝"	1.0 - 2.5	£4.00	£6.75
030713	4.3	3BA	2.5 - 6.0	£3.47	£5.59
030714	5.3	3BA	2.5 - 6.0	£3.83	£6.05
030715	6.4	¼"	2.5 - 6.0	£4.70	£7.60
030716	8.3	⅜"	2.5 - 6.0	£4.74	£7.67
030717	10.4	⅝"	2.5 - 6.0	£6.05	£9.68

### YOU MAY ALSO BE INTERESTED IN:

- Neoprene Sleeves - p.24
- Neoprene Sleeve Application Tool - p.237

## NON-INSULATED TERMINAL STARTER KIT



Contains a selection of non-insulated 6.3mm blade and piggyback terminals and non-insulated ring terminals together with suitable insulation sleeves. 260 pieces in total. Packed in a robust plastic case with dividers. *Refill option (160109-RF) also available.*

**160109** £24.07

**160109-RF** £19.43

## NON-INSULATED TERMINAL PROFESSIONAL KIT



Contains a large selection of non-insulated blade, piggyback, ring and 4.7mm bullet terminals, plus insulation sleeves and bullet connectors. 1000 pieces in total. Packed in a robust plastic case with dividers. *Refill option (160110-RF) also available.*

**160110** £82.18

**160110-RF** £76.24

## HEAVY-DUTY NON-INSULATED RING TERMINALS



For more heavy-duty applications. Made either from brass or tin-plated brass.

Part No.	Hole Dia. (mm)	Imperial	Cable Size (mm <sup>2</sup> )	10	25
030806	4.3	3BA	0.8 - 2.0	-	£3.01
030801	5.4	2BA	0.8 - 2.0	-	£3.45
030802	6.4	¼"	0.8 - 4.0	-	£4.58
030803	8.4	⅜"	0.8 - 4.0	-	£4.91
030804	9.8	⅝"	up to 5.0	£6.47	£12.97

## NON-INSULATED STANDARD BULLETS



Suitable for crimping or soldering.

### YOU MAY ALSO BE INTERESTED IN:

- Bullet Connectors - p.54
- Tools for Standard Bullets - p.234

Part No.	OD (mm)	Max. Cable Size (mm <sup>2</sup> )	10	50
031004	4.7	0.65	£3.70	£15.73
031001	4.7	1.0	£3.03	£13.46
031002	4.7	2.0	£1.46	£5.79
031003	4.7	3.0	£2.49	£11.25

## JAPANESE BULLETS, SOCKETS & INSULATORS



These bullets and sockets are slightly smaller than traditional bullets and sockets found on older UK cars and bikes. They were used on many makes of cars and also many Japanese bikes. Can be soldered or crimped. Suitable for cables 0.5 - 2.5mm<sup>2</sup>, 3.9mm OD.

The double socket is particularly useful for joining 3 wires together.

Part No.	Type	10	25	50
031301	Bullet	-	£3.26	£5.20
031302	Bullet Insulator	-	£1.98	£3.16
031303	Socket	-	£2.68	£4.22
031304	Socket Insulator	-	£1.98	£3.16
031305	Double Socket	£1.11	-	£5.01
031306	Double Socket Insulator	£0.83	-	£3.74

### YOU MAY ALSO BE INTERESTED IN:

- Crimping Tool for Non-Insulated Terminals - p.233

## BULLET KIT (NON-INSULATED)



175 bullets (4.7mm dia) suitable for crimping or soldering in four different wire sizes (0.65 - 3.00 mm<sup>2</sup>), together with 50 single and 25 double bullet connectors. Supplied in a robust plastic case with dividers.

*Refill option (160106-RF) also available.*

160106	£50.73
160106-RF	£46.10

## JAPANESE BULLET KIT



50 Japanese bullets and sockets, together with 50 insulators for each, together with 20 double bullet sockets and insulators. Supplied in a robust plastic case with dividers.

*Refill option (160123-RF) also available.*

160123	£21.80
160123-RF	£17.85

## HOLLOW OLD-STYLE BULLETS



Old style hollow bullets. 4.6mm OD. Strip cable, push into bullet and fold strands over.

Part No.	OD (mm)	Max. Cable Size (mm <sup>2</sup> )	10	50
031006	4.6	2.0	£1.76	£7.47

## BULLET CONNECTORS

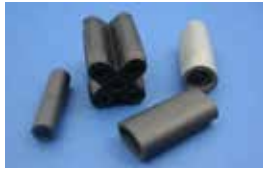

For use with all 4.7mm diameter bullets - p.52. 031102 is "common", meaning all incoming cables are electrically connected together.

Part No.	Type	Each	10	50
031101	Single	-	£1.87	£7.56
031102	Double (common)	-	£2.02	£8.02
031104	5-way	£5.88	£54.09	-
031106	Triple	£3.62	£32.61	-

## BULLET SOCKETS



Can be soldered or crimped. Accepts 4.7mm dia. bullets- p.52. Comes complete with insulation sleeve.

Part No.	10	50
031201	£6.46	£25.82

### YOU MAY ALSO BE INTERESTED IN:

- Bullet inserting tool - p.234
- Crimping tool for bullets - p.234

## INSULATED TERMINALS - MALE BLADE



Made from high conductivity copper strip, tinned for corrosion resistance. Colour coded insulation sleeve extends beyond the crimping area to grip and support the cable insulation.

Part No.	Width (mm)	Cable Size (mm <sup>2</sup> )	Colour	25	50
040101	4.8	0.5 - 1.5	Red	£2.47	£3.86
040102	6.3	0.5 - 1.5	Red	£2.47	£3.86
040104	6.3	1.5 - 3.0	Blue	£2.52	£3.99
040105	6.3	3.0 - 6.0	Yellow	£2.95	£4.77

## INSULATED TERMINALS - FEMALE BLADE



Made from high conductivity copper strip, tinned for corrosion resistance. Colour coded insulation sleeve extends beyond the crimping area to grip and support the cable insulation.

Part No.	Width (mm)	Cable Size (mm <sup>2</sup> )	Colour	25	50
040201	2.8	0.5 - 1.5	Red	£2.18	£3.51
040202	4.8	0.5 - 1.5	Red	£2.95	£4.80
040203	6.3	0.5 - 1.5	Red	£2.77	£4.42
040204	4.8	1.5 - 3.0	Blue	£2.92	£4.69
040205	6.3	1.5 - 3.0	Blue	£2.86	£4.60
040206	6.3	3.0 - 6.0	Yellow	£3.32	£5.29
040207	9.5	3.0 - 6.0	Yellow	£5.71	£9.07

## FULLY INSULATED TERMINALS - FEMALE BLADE



Made from high conductivity copper strip, tinned for corrosion resistance. Colour coded insulation sleeve extends beyond the crimping area to grip and support the cable insulation.

Part No.	Width (mm)	Cable Size (mm <sup>2</sup> )	Colour	25	50
040301	4.8	0.5 - 1.5	Red	£3.56	£5.64
040302	6.3	0.5 - 1.5	Red	£3.59	£5.67
040307	2.8	1.5 - 3.0	Blue	£3.53	£5.60
040303	4.8	1.5 - 3.0	Blue	£3.69	£5.82
040304	6.3	1.5 - 3.0	Blue	£3.65	£5.78
040305	6.3	3.0 - 6.0	Yellow	£5.08	£8.10
040306	9.5	3.0 - 6.0	Yellow	£9.11	£14.63

## INSULATED TERMINALS - PIGGY BACK



Made from high conductivity copper strip, tinned for corrosion resistance. Colour coded insulation sleeve extends beyond the crimping area to grip and support the cable insulation.

Part No.	Width (mm)	Cable Size (mm <sup>2</sup> )	Colour	25	50
040401	6.3	0.5 - 1.5	Red	£3.81	£5.47
040402	6.3	1.5 - 3.0	Blue	£3.69	£5.80
040403	6.3	3.0 - 6.0	Yellow	£5.65	£8.99

## INSULATED TERMINALS - RING



Made from high conductivity copper strip, tinned for corrosion resistance. Colour coded insulation sleeve extends beyond the crimping area to grip and support the cable insulation.

Part No.	Hole Dia. (mm)	Imperial Size	Cable Size (mm <sup>2</sup> )	Colour	25	50
040501	3.2	4BA	0.5 - 1.5	Red	£1.70	£2.77
040502	4.3	3BA	0.5 - 1.5	Red	£1.80	£2.91
040503	5.3	2BA	0.5 - 1.5	Red	£1.94	£3.09
040504	6.4	¼"	0.5 - 1.5	Red	£2.40	£3.83
040505	8.4	⅝"	0.5 - 1.5	Red	£2.55	£4.06
040506	10.5	⅞"	0.5 - 1.5	Red	£3.65	£5.79
040507	12.0	½"	0.5 - 1.5	Red	£3.98	£6.37
040508	4.3	3BA	1.5 - 3.0	Blue	£2.04	£3.27
040509	5.3	2BA	1.5 - 3.0	Blue	£2.04	£3.27
040510	6.4	¼"	1.5 - 3.0	Blue	£2.55	£4.06
040511	8.4	⅝"	1.5 - 3.0	Blue	£2.65	£4.19
040512	10.5	⅞"	1.5 - 3.0	Blue	£3.32	£5.30
040513	12.0	½"	1.5 - 3.0	Blue	£4.86	£7.78
040514	4.3	3BA	3.0 - 6.0	Yellow	£2.84	£4.55
040515	5.3	2BA	3.0 - 6.0	Yellow	£3.10	£5.01
040516	6.4	¼"	3.0 - 6.0	Yellow	£3.59	£6.11
040517	8.4	⅝"	3.0 - 6.0	Yellow	£4.41	£7.04
040518	10.5	⅞"	3.0 - 6.0	Yellow	£4.38	£6.96
040519	12.0	½"	3.0 - 6.0	Yellow	£6.17	£9.94

## INSULATED TERMINAL KIT



Contains 270 insulated terminals (18 types including male and female blades, bullets, sockets and ring terminals) packed into a robust plastic case with dividers.

*Refill option (160102-RF) also available.*

<b>160102</b>	<b>£37.35</b>
<b>160102-RF</b>	<b>£32.72</b>

## INSULATED TERMINAL KIT WITH TOOL



Contains 590 insulated terminals (24 types including male and female blades, bullets, sockets, piggy backs and ring terminals) together with a crimping tool. Packed into a robust plastic case with dividers.

*Refill option (160101-RF) also available.*

<b>160101</b>	<b>£70.92</b>
<b>160101-RF</b>	<b>£60.39</b>

## INSULATED TERMINALS - BULLETS



Made from high conductivity copper strip, tinned for corrosion resistance. Colour coded insulation sleeve extends beyond the crimping area to grip and support the cable insulation.

Available in two diameters (4.0 and 5.0mm), depending on cable size.

Part No.	Dia. (mm)	Cable Size (mm <sup>2</sup> )	Colour	25	50
<b>040601</b>	4.0	0.5 - 1.5	Red	<b>£2.55</b>	<b>£4.05</b>
<b>040602</b>	4.0	1.5 - 3.0	Blue	<b>£3.26</b>	<b>£5.20</b>
<b>040603</b>	5.0	1.5 - 3.0	Blue	<b>£3.26</b>	<b>£5.20</b>
<b>040604</b>	5.0	3.0 - 6.0	Yellow	<b>£5.95</b>	<b>£9.51</b>

## INSULATED TERMINALS - BULLET SOCKETS



Made from high conductivity copper strip, tinned for corrosion resistance. Colour coded insulation sleeve extends beyond the crimping area to grip and support the cable insulation.

Available in two diameters (4.0 and 5.0mm), depending on cable size.

Part No.	Dia. (mm)	Cable Size (mm <sup>2</sup> )	Colour	25	50
<b>040801</b>	4.0	0.5 - 1.5	Red	<b>£2.95</b>	<b>£4.80</b>
<b>040802</b>	4.0	1.5 - 3.0	Blue	<b>£3.32</b>	<b>£5.29</b>
<b>040803</b>	5.0	1.5 - 3.0	Blue	<b>£3.32</b>	<b>£5.29</b>
<b>040804</b>	5.0	3.0 - 6.0	Yellow	<b>£6.21</b>	<b>£10.01</b>

## INSULATED TERMINALS - BUTT CONNECTORS



Made from high conductivity copper strip, tinned for corrosion resistance. Colour coded insulation sleeve extends beyond the crimping area to grip and support the cable insulation.

Useful to join two cables together.

Part No.	Cable Size (mm <sup>2</sup> )	Colour	25	50
<b>040901</b>	0.5 - 1.5	Red	<b>£2.55</b>	<b>£4.06</b>
<b>040902</b>	1.5 - 3.0	Blue	<b>£2.68</b>	<b>£4.22</b>
<b>040903</b>	3.0 - 6.0	Yellow	<b>£4.74</b>	<b>£7.57</b>



## INSULATED TERMINALS - BULLETS



Made from high conductivity copper strip, tinned for corrosion resistance. Colour coded insulation sleeve extends beyond the crimping area to grip and support the cable insulation.

Part No.	Slot Width (mm)	Cable Size (mm <sup>2</sup> )	Colour	25	50
040701	4.3	0.5 - 1.5	Red	£1.94	£3.09
040702	5.3	0.5 - 1.5	Red	£1.94	£3.09
040703	6.4	0.5 - 1.5	Red	£2.18	£3.57
040704	4.3	1.5 - 3.0	Blue	£1.83	£2.95
040705	5.3	1.5 - 3.0	Blue	£1.92	£2.98
040706	6.4	1.5 - 3.0	Blue	£2.55	£4.05
040707	4.3	3.0 - 6.0	Yellow	£2.65	£4.20
040708	5.3	3.0 - 6.0	Yellow	£2.80	£4.43
040709	6.4	3.0 - 6.0	Yellow	£3.77	£6.03

## SELF-STRIPPING CONNECTORS



A range of self-stripping connectors that provide a quick yet effective means of joining a second or tapping cable to an existing wire.

Part No.	Cable Size (mm <sup>2</sup> )	Colour	Tapping Cable (mm <sup>2</sup> )	25	50
041201	0.65 - 2.0	Red	0.65	£3.44	£4.33
041202	0.65 - 2.0	Blue	0.65 - 2.0	£3.44	£4.33
041203	3.0 - 4.5	Yellow	3.0 - 4.5	£7.02	£11.20

## HEAT-SHRINK TERMINALS - MALE BLADES



These terminals offer superior performance over standard crimp terminals. After crimping, the hot-melt glue lined heatshrink sleeve is heated and shrunk down onto the cable. This increases the mechanical strength of the termination and its resistance to corrosion, as the melted glue effectively seals the joint.

Part No.	Width (mm)	Cable Size (mm <sup>2</sup> )	Colour	10	50
041101	6.3	0.5 - 1.5	Red	£6.30	£25.17
041102	6.3	1.5 - 3.0	Blue	£6.30	£25.17

## HEAT-SHRINK TERMINALS - FEMALE BLADES



These fully-insulated terminals offer superior performance over standard crimp terminals. After crimping, the hot-melt glue lined heatshrink sleeve is heated and shrunk down onto the cable. This increases the mechanical strength of the termination and its resistance to corrosion, as the melted glue effectively seals the joint.

Part No.	Width (mm)	Cable Size (mm <sup>2</sup> )	Colour	10	50
041103	6.3	0.5 - 1.5	Red	£7.18	£28.62
041104	6.3	1.5 - 3.0	Blue	£7.18	£28.62

## HEAT-SHRINK TERMINALS - BUTT CONNECTORS



Useful for joining two cables together. The cables are inserted, the connector crimped and then heated with a hot air gun, causing the heatshrink sleeve to shrink around the crimped connector. This helps give a watertight connection.

Part No.	Colour	10	50
041105	Red	£5.51	£22.07
041106	Blue	£6.30	£25.17
041107	Yellow	£7.09	£28.28

## HEAT-SHRINK TERMINALS - RING TERMINALS



These terminals offer superior performance over standard crimp terminals. After crimping, the hot-melt glue lined heatshrink sleeve is heated and shrunk down onto the cable. This increases the mechanical strength of the termination and its resistance to corrosion, as the melted glue effectively seals the joint.

Part No.	Hole Dia. (mm)	Cable Size (mm <sup>2</sup> )	Colour	10	50
041108	4.0	0.5 - 1.5	Red	£5.61	£22.42
041109	5.0	0.5 - 1.5	Red	£5.61	£22.42
041110	6.0	0.5 - 1.5	Red	£6.30	£25.17
041111	4.0	1.5 - 3.0	Blue	£5.61	£22.42
041112	5.0	1.5 - 3.0	Blue	£6.30	£25.17
041113	6.0	1.5 - 3.0	Blue	£6.64	£26.57
041114	8.0	1.5 - 3.0	Blue	£6.64	£26.57
041116	5.0	3.0 - 6.0	Yellow	£6.97	£27.95
041117	6.0	3.0 - 6.0	Yellow	£7.58	£30.41
041118	8.0	3.0 - 6.0	Yellow	£8.43	£33.79

## HEAT-SHRINK SOLDER BUTT CONNECTORS



Solder butt connectors with adhesive lined heat shrink sleeving. Insert stripped cables into the connectors and heat with a hot air gun. This melts the solder and also shrinks the heat shrink tubing sealing the connection.

Part No.	Cable Size (mm <sup>2</sup> )	Colour	10	50
041150	0.5 - 1.5	Red	£7.63	£34.34
041151	1.5 - 3.0	Blue	£7.90	£35.57
041152	3.0 - 6.0	Yellow	£9.17	£41.19

### YOU MAY ALSO BE INTERESTED IN:

- Universal Mate-N-Lok Pin Extractor - p.237

## MATE-N-LOK CONNECTORS - UNIVERSAL



These multiple connectors use 2mm diameter round pins locked into plastic housings. Available from two to 15 pins. Supplied as a pair of male/female housings that positively lock together, together with all terminals. Suitable for cables up to 2mm<sup>2</sup>. Maximum current 10A per terminal.

For higher current applications use the 3.5mm Mate-N-Lok connectors.

Part No.	No. of Terminals	Face Dimensions (mm)	Each	10
051301	2	8 x 14	£2.05	£17.27
051302	3	8 x 21	£2.38	£20.18
051303	6	21 x 14	£3.72	£31.53
051304	9	21 x 21	£4.74	£40.36
051305	12	21 x 27	£5.87	£50.04
051306	15	21 x 33	£7.32	£62.20

## SPARE PINS & SOCKETS - UNIVERSAL



Part No.	Type	10	50
051310	Pin	£2.00	£8.30
051311	Socket	£2.00	£8.30

## HEAT-SHRINK TERMINAL KIT



Contains a selection of heat-shrink blade terminals, ring terminals and butt connectors. 65 pieces in total. Packed in a robust plastic case with dividers.

Refill option (160120-RF) also available.

160120	£35.37
160120-RF	£30.74

## UNIVERSAL MATE-N-LOK KIT



Contains a selection of 31 pairs of 2mm pin universal mate-n-lok connector housings, from 2 to 15 ways. Supplied with 400 terminals. Packed into a robust plastic case with dividers.

160121	£101.24
--------	---------

## MATE-N-LOK CONNECTORS - MINI



Based on the "Mate-N-Lok" range, but much smaller. For low current applications where space is at a premium. These multiple connectors use 1mm diameter round pins locked into plastic housings. Available from two to 15 pins. Supplied as a pair of male/female housings that positively lock together, together with all terminals. Suitable for cables up to 1.2mm<sup>2</sup>. Maximum current 5A per terminal.

Part No.	No. of Terminals	Face Dimensions (mm)	Each	10
051401	2	6 x 11	£2.16	£18.53
051402	3	6 x 15	£2.67	£22.67
051403	4	10 x 12	£3.29	£27.94
051404	6	14 x 12	£4.74	£40.36
051405	9	14 x 16	£6.31	£53.63
051406	12	18 x 16	£8.15	£69.10
051407	15	22 x 16	£9.44	£80.17

## SPARE PINS & SOCKETS - MINI



Part No.	Type	10	50
051410	Pin	£2.42	£9.70
051411	Socket	£2.42	£9.70

## MATE-N-LOK CONNECTORS - 3.5mm



These multiple connectors use 3.5mm diameter round pins, locked into plastic housings. Available from 2-9 pins. Supplied as a pair of male/female housings that positively lock together, together with all terminals. Suitable for cables between 2.0-5.0 sq mm. Max. current approx. 20A per terminal (dependent upon cable size used and the number of pins in the connector).

Part No.	No. of Terminals	Face Dimensions (mm)	Each	10
055001	2	7 x 13	£4.83	£41.06
055002	3	7 x 19	£5.76	£49.00
055003	4	13 x 19	£6.66	£56.58
055004	9	19 x 19	£6.95	£62.54

## SPARE PINS & SOCKETS - 3.5mm



Part No.	Type	Each	10
TYCO 925662-1	Pin	£0.45	£4.05
TYCO 925663-1	Socket	£0.68	£5.81

## 6.3mm MULTIPLE CONNECTORS - HOUSINGS ONLY



These multiple connectors use 6.3mm blade terminals locked into plastic housings. They are available from 1 to 11 ways (1 pair of connectors to 11 pairs) and are supplied as a pair of male and female quick release nylon connector housings.

*Terminals are available in two different sizes and must therefore be bought separately - see below.*

Part No.	No. of Terminals	Each	10
050101	1	£0.48	£4.17
050102	2	£0.65	£5.59
050107	2 (T-shape)	£0.71	£6.34
050103	3	£0.75	£6.71
050104	4	£0.91	£7.84
050105	6	£1.02	£8.95
050106	8	£1.28	£11.19
050108	11	£3.11	£26.99

## 6.3mm MULTIPLE CONNECTORS - TERMINALS



The terminals for the above housings are available for two different wire sizes and therefore must be purchased separately. Terminals are secured by crimping or soldering.

Part No.	Type	Cable Size (mm <sup>2</sup> )	Each	10	50
050201	Male	1.0 - 2.5	£0.09	£0.61	£2.89
050203	Female	1.0 - 2.5	£0.09	£0.61	£2.89
050202	Male	2.5 - 6.0	£0.20	£1.32	£6.27
050204	Female	2.5 - 6.0	£0.20	£1.32	£6.27

## 6.3mm MULTIPLE CONNECTOR KIT



Contains a selection of 70 pairs of 6.3mm blade multiple connector housings from 1 to 11 ways. Supplied with 400 terminals. Supplied in a robust plastic case with dividers.

**160115**

**£82.46**

## SUPERSEAL CONNECTOR KIT



Contains a selection of superseal multiple connector housings from 1 to 6 ways. Supplied with all required terminals and seals and some spares. Supplied in a robust plastic case with dividers.

**160132**

**£47.81**

## WATERPROOF CONNECTORS - ECONOSEAL



Water-proof connectors. Suitable for cables up to 1mm<sup>2</sup>. **Supplied with all seals and terminals.** Terminals are 1.85mm wide x 0.6mm thick.

Face dimensions are shown in the table below.

Part No.	No. of Terminals	Type	Dimensions (mm)	Each	10
<b>051201</b>	2	Male	18 x 13	<b>£2.85</b>	<b>£25.49</b>
<b>051202</b>	2	Female	21 x 18	<b>£3.24</b>	<b>£29.16</b>
<b>051203</b>	3	Male	23 x 13	<b>£3.38</b>	<b>£30.43</b>
<b>051204</b>	3	Female	26 x 18	<b>£3.38</b>	<b>£30.43</b>

### YOU MAY ALSO BE INTERESTED IN:

- Crimping Tool for Econoseal & Superseal Terminals - p.234

## WATERPROOF CONNECTORS - SUPERSEAL 1.5mm



Water-proof multiple connectors, 1 to 6 way. Supplied in pairs with all seals and terminals. Terminals can take cables up to 1.5mm<sup>2</sup>. Current rating up to 14A per terminal.

Conduit Superseal Interfaces are also available for connecting seamlessly to convoluted sleeving- p.25.

Part No.	No. of Terminals	Type	Dimensions (mm)	Each	10
<b>050601</b>	1	Pair	54 x 14 x 14	<b>£3.33</b>	<b>£28.31</b>
<b>050602</b>	2	Pair	54 x 19 x 14	<b>£4.39</b>	<b>£37.35</b>
<b>050603</b>	3	Pair	54 x 25 x 14	<b>£6.10</b>	<b>£52.00</b>
<b>050604</b>	4	Pair	54 x 32 x 14	<b>£7.20</b>	<b>£61.30</b>
<b>050605</b>	5	Pair	54 x 38 x 14	<b>£9.27</b>	<b>£78.81</b>
<b>050606</b>	6	Pair	53 x 44 x 14	<b>£10.66</b>	<b>£90.53</b>

## SPARE TERMINALS & SEALS - SUPERSEAL 1.5mm



Part No.	Type	Each	10	100
<b>050607</b>	Male Terminal	-	<b>£2.02</b>	<b>£17.02</b>
<b>050608</b>	Female Terminal	-	<b>£2.59</b>	<b>£21.85</b>
<b>050609</b>	Seal	<b>£0.16</b>	<b>£1.25</b>	-

## FEMALE INSULATORS - LATCHED



Insulators with latching clip to take female 6.3mm blades with tags. Useful on applications such as starter motors & alternators etc.

Part No.	Type	Each
<b>050109</b>	Single terminal, white	<b>£0.79</b>
<b>050110</b>	Double terminal, black	<b>£1.03</b>
<b>050203</b>	6.3mm female terminal with tag	<b>£0.09</b>

## WATERPROOF CONNECTORS - SUPERSEAL 2.8mm



Water-proof multiple connectors, 1 to 3 way. Supplied in pairs with all seals and terminals. Terminals can take cables up to 2mm<sup>2</sup>. Blade dimensions 2.8mm wide x 0.8mm thick. This range of connectors are the bigger versions of the 1.5mm Superseal range.

Part No.	No. of Terminals	Type	Dimensions (mm)	Each	10
050701	1	Pair	63 x 16 x 15	£5.20	£44.25
050702	2	Pair	63 x 23 x 15	£6.27	£53.43
050703	3	Pair	66 x 30 x 15	£10.37	£88.20

### SPARE TERMINALS & SEALS - SUPERSEAL 2.8mm



Part No.	Type	Each	10
050704	Male Terminal	£0.41	£3.30
050705	Female Terminal	£0.41	£3.30
050706	Seal	£0.17	£1.32

## LUCAS/BOSCH ALTERNATOR PLUG



Black plastic plug servicing most Bosch and Lucas alternators. Supplied as plastic housing with lid and 2 x 9.5mm and 1 x 6.3 female blade connectors.

**050901**  
**£4.56**

## LUCAS WHB102 WIPER PLUG



Lucas WHB102 wiper plug (5 terminals) with flying lead approximately 30cm long.

**WHB102**  
**£9.91**

## JUNIOR POWER TIMER CONNECTORS - HOUSINGS ONLY



Female housings are available in 4 different configurations with either 2, 3, 4, or 5 terminals.

Only one male housing is stocked, which has 2 terminals.

*Terminals for the housings should be purchased separately as they are available for two different cable sizes - see below.*

Part No.	Type	No. of Terminals	Each	10
051501	Female	2	£1.64	£13.83
051502	Female	3	£2.37	£20.12
051503	Female	4	£4.06	£34.57
051504	Female	5	£5.17	£44.00
051507	Male	2	£7.26	£64.83

### TERMINALS, WIRE SEALS & RUBBER BOOTS



Part No.	Type	No. of Terminals	Cable Size (mm <sup>2</sup> )	Each	10
051601	Female Terminal	-	0.5- 1.0	£0.54	£4.43
051603	Male Terminal	-	0.5- 1.0	£0.54	£4.43
051602	Female Terminal	-	1.5- 2.5	£0.54	£4.43
051604	Male Terminal	-	1.5- 2.5	£0.54	£4.43
051801	Wire seal (blue)	-	1.2- 2.1	£0.28	£2.45
051802	Wire seal (white)	-	2.2- 3.0	£0.29	£2.61
051803	Blanking seal (clear)	-	-	£0.34	£3.08
051701	90°	2	-	£1.32	£11.10
051702	Straight	3	-	£1.47	£12.43
051703	Straight	2	-	£1.17	£10.36

#### YOU MAY ALSO BE INTERESTED IN:

- Crimping Tool for Junior Power Timer Terminals - p.234



## 3-PIN PLUG/SOCKET



3 pin black thermoplastic plug/socket having two larger pins and 1 small pin. All terminals are nickel plated and are rated at 2 x 25A and 1 x 5A respectively. Plug diameter 30mm and overall length 70mm and comes with plastic dust cap for when not in use. Socket has mounting flange and spring loaded cap to prevent water ingress when not in use & rubber cable shroud. Internal connections via 2 x 6.3mm & 1 x 4.8mm blade terminals.

Part No.	Type	Each
<b>052001</b>	Socket	<b>£7.62</b>
<b>052002</b>	Plug	<b>£7.62</b>

## 'CLANG' CONNECTORS



3 pin 'Clang' heavy duty connectors. Passivated zinc alloy case, having nickel plated brass pins and sockets. 25A continuous, 45A intermittent.



Part No.	Type	Each
<b>052003</b>	Plug	<b>£31.05</b>
<b>052004</b>	Socket	<b>£32.36</b>

## TERMINAL BLOCK - 7-WAY



Terminal block with 7 common screw connections. Single mounting hole. Plastic part is 60mm x 15mm. The metal block is 51mm x 6 mm. Max cable approx 10mm<sup>2</sup>.

<b>051110</b>
<b>£6.70</b>

## BLADE TERMINAL CONNECTORS



Insulated connectors to join two or three 6.3mm female blade terminals together. The twelve way strip can be cut into smaller strips.



Part No.	Type	Each	10
<b>051101</b>	Connector to join two blade terminals	<b>£0.43</b>	<b>£3.63</b>
<b>051102</b>	Strip of twelve of the above	<b>£2.77</b>	<b>£23.67</b>
<b>051103</b>	Connector to join three blade terminals	<b>£0.72</b>	<b>£6.39</b>

## TERMINAL BLOCK - STANDARD PVC 12-WAY



PVC terminal blocks with screw terminals.

Part No.	Max. Cable Size (mm <sup>2</sup> )	Each	10
<b>051104</b>	3.0	<b>£0.79</b>	<b>£6.75</b>
<b>051105</b>	4.0	<b>£0.99</b>	<b>£8.41</b>
<b>051106</b>	6.0	<b>£1.46</b>	<b>£13.07</b>

## TERMINAL BLOCK - PLUG TOGETHER



Pair of male/female 12-way terminal blocks that can be plugged together and easily cut down to smaller units. Pin size 2.6mm. Maximum cable 44/0.30 (3mm<sup>2</sup>).

<b>051107</b>
<b>£6.23</b>



## TERMINAL BLOCK - SCREW/SCREW



Terminal blocks with screw/screw terminations. Made from black filled polyester with chassis fixing holes. Require ring terminals with a 4mm diameter hole.

Part No.	Type	Each
051108	4-way	£4.95
051109	12-way	£9.69

## TERMINAL BLOCK - 2 x 4 WAY



2 x 4 way. 6.3mm common plated brass blade terminals. 25 amp capacity. Phenolic base with mounting hole. L 12 x W 50 x H 22mm.

<b>051111</b>
<b>£4.15</b>

## TERMINAL BLOCK - 3 x 6 WAY



3 x 6 way. 6.3mm common plated brass blade terminals. 5 amp. Phenolic base with mounting hole. L 28 x W 50 x H 22 mm

<b>051112</b>
<b>£6.37</b>

## SPARK PLUG TERMINALS - SOLDER-ON



Older style blade type solder-on spark plug terminals. Made from brass.

Part No.	Each	10
060103	£1.48	£12.61

## SPARK PLUG TERMINALS - CRIMP-ON (STRAIGHT)



Black silicone rubber covers and crimped-on plated steel terminals. Suitable for 7mm ignition cable.

Part No.	Type	Each	10
060101	Terminal	£0.25	£2.02
060201	Cover	£0.76	£6.21

## SPARK PLUG TERMINALS - CRIMP-ON (90°)



Black silicone rubber covers and crimped-on plated steel terminals. Suitable for 7mm ignition cable.

Part No.	Type	Each	10
060102	Terminal	£0.32	£2.59
060202	Cover	£1.20	£9.86

### YOU MAY ALSO BE INTERESTED IN:

- Crimping Tool for HT Terminals - p.235

## HT TERMINAL KIT



Contains a selection of straight and 90° HT spark plug and distributor/coil terminals and covers. 133 items in total. Packed in a robust plastic case with dividers. Contents easily sufficient to make six 4-cylinder vehicle HT lead sets.

**160107**

**£54.93**

## HT TERMINAL KIT - WITH TOOL



Contains a selection of straight and 90° HT spark plug and distributor/coil terminals and covers. 133 items in total. Packed in a robust plastic case with dividers. Contents easily sufficient to make six 4-cylinder vehicle HT lead sets. Crimping tool (150601) included.

**160108**

**£88.05**

## SPARK PLUG THUMB NUTS



Machined brass thumb nuts to fit spark plugs. Available in two sizes. Small (9.4mm diameter) & large (12.1mm diameter).

Part No.	Type	Each
<b>060104</b>	Small	<b>£0.93</b>
<b>060105</b>	Large	<b>£1.12</b>

## SPARK PLUG SPRING CLIPS



Spark plug spring clip for use with blade type terminals (060103- p.73). KLG type.

**060106**

**£1.83**

## IN-LINE SUPPRESSOR



In-line ignition suppressor. Has screw thread at both ends so it can fixed onto an HT cable. Made from brown phenolic plastic with a 5K $\Omega$  carbon suppressor. 58mm long x 11mm diameter.

**060603**

**£1.92** each

**£17.46** / 10

## STRAIGHT NON-SUPPRESSED PLUG CAP



Black phenolic straight plug cap, 70mm long. Screws on to HT cable and clips on to M4 thread on top of spark plug.

**060501**

**£2.47** each

**£22.29** / 10

## RUBBER 90° NON-SUPPRESSED PLUG CAP



Rubber spark plug cap with cable sealing clamp. This cap is non-suppressed, and has a clamp to seal around the HT cable making it effectively waterproof. HT cable screws into the cap. Fits on to metal cap type spark plugs.

**060502**

**£3.23** each

## CHAMPION RUBBER NON-SUPPRESSED PLUG CAP



Rubber plug caps, made by Champion, non suppressed. Being rubber, they seal around the ceramic part of the spark plug, stopping ingress of water. Screw onto HT cable and fit onto metal cap type spark plugs

**060607**

**£7.86** each

**£70.77** / 10

## CHAMPION WCX600 SUPPRESSED PLUG CAP



Champion WCX600 90° suppressed plug cap. Fitted with a 10K $\Omega$  suppressor. Screws onto HT cable. Fits on to metal cap type spark plugs.

**060606**

**£8.04** each

**£72.47** / 10

## STRAIGHT SUPPRESSED PLUG CAP



Brown phenolic spark plug caps with a 5K $\Omega$  carbon suppressor. *(Note: these plug caps are unsuitable for use with high power electronic ignition systems)*. These plug caps screw onto the HT cable and clip on to the spark plug. (The spark plug requires the aluminium ferrule on its thread, for the cap to clip on to- SAE fitting). Approx 70mm long x 20mm diameter at the widest point.

**060601**

**£3.47** each

**£31.21** / 10

## HT TERMINALS



Brass. Suitable for 7mm ignition cable.



060304

Part No.	Type	Suitable Cover(s)	Each	10
<b>060301</b>	Straight	060401 / 060403 / 060405	<b>£0.30</b>	<b>£2.74</b>
<b>060302</b>	90°	060404	<b>£0.44</b>	<b>£3.66</b>
<b>060304</b>	Cap	060401 / 060403 / 060405	<b>£0.53</b>	<b>£4.46</b>

## DISTRIBUTOR/COIL TERMINALS (SCREW ON)



Brass. Suitable for 7mm ignition cable.

**060303**

**£1.08** each

**£9.92** / 10

## "BOSCH" DISTRIBUTOR TERMINALS



HT terminals to fit Bosch distributor caps having 4mm diameter pin terminals. Stainless steel. To suit 7 & 8mm diameter HT cable.

**060305**

**£0.93** each

**£8.33** / 10

### YOU MAY ALSO BE INTERESTED IN:

- Crimping Tool for HT Terminals - p.235
- HT cable markers - p.27

## DISTRIBUTOR/COIL COVERS



060405



060401



060403



060404

**060405/060401/060403:** Covers suitable for use on ignition coils and distributor caps. For use with 6 & 7mm HT cable.

**060404:** Black PVC. Suitable for 7mm ignition cable. Has internal diameter of 14mm.

Part No.	Type	Int. Dia. (mm)	Each	10
<b>060405</b>	Distributor cover	14	<b>£0.34</b>	<b>£3.01</b>
<b>060401</b>	Distributor cover	15	<b>£0.34</b>	<b>£3.01</b>
<b>060403</b>	Coil cover	19	<b>£0.25</b>	<b>£2.10</b>
<b>060404</b>	Distributor/coil cover (90°)	14	<b>£0.50</b>	<b>£4.26</b>

## IGNITION LEAD SEPARATORS



Black nylon clip-on ignition lead separators. Available in two, three and four lead versions.

Part No.	Type	Each
<b>061001</b>	For 2 ignitions leads	<b>£0.26</b>
<b>061002</b>	For 3 ignition leads	<b>£0.32</b>
<b>061003</b>	For 4 ignition leads	<b>£0.43</b>

## GENERAL IGNITION COILS



060701

060702

060705

060704



060706

060707

These ignition coils have two terminals, marked + & -, together with the HT connection. In order to ensure that the spark has the correct polarity (for optimum performance), connect in the following manner:

Negative Earth Systems: + to supply voltage, - to contact breaker

Positive Earth Systems: - to supply voltage, + to contact breaker

### Standard/Ballast/Electronic Coils

Metal cans with bakelite or polyester (060705) insulation. Connections via M5 studs or spade terminals. Coils are supplied with bolt-on 6.3mm male blades which can easily be removed to leave the studs available. HT connection via push-in terminal (060301, 060302 or 060303 - p.76). Suitable cover: 060403 - p.77. Body diameter 55mm with a cap diameter of approximately 65mm. Total length approximately 150mm.

\* Requires ballast resistor: 060703 - p.80.

### Acorn Coils

Older style screw terminal (acorn) HT connection. Low tension connections are 5mm studs which come complete with removable spade terminal connections. Suitable brass washers for terminating the HT cable are: 060803 - p.82. Dimensions as above (length excluding acorn).

Part No.	6V/12V	Type	Primary Resistance ( $\Omega$ )	Each
<b>060701</b>	12V	Standard	3.0	<b>£18.83</b>
<b>060702 *</b>	12V	Ballast	1.5	<b>£18.83</b>
<b>060705</b>	12V	Electronic	1.6	<b>£20.35</b>
<b>060704</b>	6V	Standard	1.5	<b>£22.89</b>
<b>060706</b>	12V	Acorn	3.3	<b>£22.21</b>
<b>060707</b>	6V	Acorn	1.5	<b>£23.32</b>

## LUCAS 12V IGNITION COILS



060710

060711

060712

060713



060714

060717

These ignition coils have two terminals, marked + & -, together with the HT connection. In order to ensure that the spark has the correct polarity (for optimum performance), connect in the following manner:

Negative Earth Systems: + to supply voltage, - to contact breaker

Positive Earth Systems: - to supply voltage, + to contact breaker

**060710/060711:** Standard 12V Lucas ignition coil. Has push in HT connection. Diameter 53mm. Suitable connector: 060301 - p.76 & cover: 060403 - p.77.

**060712/060713:** A high performance 12V Lucas ignition coil. Allows plug gap to be increased for better combustion which gives better performance and economy. Has push in HT connection. Connector and cover as 060710.

**060714:** Lucas DLB198 Ignition coil for use with electronic ignition systems. (Primary resistance 1 Ohm). Has 2 x M5 studs for connection, but also comes with bolt on tabs to convert these to 6.3mm male blades. Has push in HT connection. Suitable connector 060301 - p.76 & cover 060403 - p.77.

**060717:** Standard 12V ignition coil with older style screw terminal (acorn) HT connection. Low tension connections are 5mm studs which come complete with spade terminal connections (removable). Body diameter 55mm with a cap diameter of approximately 65mm. Total length approximately 150mm (excluding acorn). Suitable brass washers for terminating the HT cable when using with acorn type connectors are: 060803 - p.82. *Please note that the acorns are not supplied with the coil - see p.82.*

\* Requires ballast resistor: 060703 - p.80.

Part No.	6V/12V	Type	Lucas Part No.	Primary Resist. ( $\Omega$ )	Each
<b>060710</b>	12V	Standard	DLB101	3.0	<b>£23.71</b>
<b>060711 *</b>	12V	Ballast	DLB102	1.5	<b>£25.19</b>
<b>060712</b>	12V	Sports	DLB105	3.0	<b>£29.12</b>
<b>060713 *</b>	12V	Sports Ballast	DLB110	1.5	<b>£35.08</b>
<b>060714</b>	12V	Electronic	DLB198	1.0	<b>£30.84</b>
<b>060717</b>	12V	Acorn	DLB100	3.5	<b>£31.84</b>

## BALLAST RESISTOR



Ballast Resistor (1.6Ω). Ceramic with metal mounting bracket.

**060703**

**£6.24**

## BOSCH IGNITION COILS - 6V & 12V



0221124001 6V high performance ignition coil. (Primary resistance 1.5Ω). Has push in HT connection. Diameter 55mm. Suitable connector 060301 (p.76) & cover 060401 (p.77).

**060725**

**£50.26**



0221119027 12V blue ignition coil. (Primary resistance 3Ω). Has push in HT connection. Diameter 55mm. Suitable connector 060301 (p.76) & cover 060401 (p.77). Supplied without mounting bracket.

**060726**

**£34.59**

## MOTORCYCLE TWIN LEAD IGNITION COIL - 6V & 12V



Twin lead ignition coil available in 6v and 12v versions. As fitted as OEM on early Japanese Bikes with points ignition. Can also be used with electronic ignition kits. The HT Leads are 23½" (590mm) long.

Mounting bolts are 3¾" (90mm) apart centre to centre.

**Black lead: Negative    Yellow lead: Positive**

Part No.	6V/12V	Primary Resistance (Ω)	Each
<b>060708</b>	6V	1.3	<b>£38.99</b>
<b>060709</b>	12V	4.0	<b>£41.52</b>

## MOTORCYCLE IGNITION COILS - 6V & 12V



Small ignition coils, suitable for use on motorcycles. Aluminium cans, 40mm diameter x 92mm tall. Total height 131mm including HT connection. Low tension connection via M4 studs. (Stud marked '15' is supply, stud marked '1' goes to points). HT cable connects by screwing into coil and is sealed by sciew-on cap and seal.

Part No.	6V/12V	Primary Resistance (Ω)	Each
<b>060721</b>	6V	1.5	<b>£28.36</b>
<b>060720</b>	12V	3.5	<b>£28.36</b>

## "LUCAS" MOTORCYCLE IGNITION COILS - 6V & 12V



Lucas oil filled ignition coils, suitable for motorcycle use. Original fitment on various British motorcycles.

HT connection via supplied push-in terminal and cover, low tension connection via 5mm studs.

- Body Length 4" (100mm) • Total length 125mm
- Body diameter : 1½" (48mm)

Part No.	6V/12V	Lucas Part No.	Primary Resistance (Ω)	Each
<b>060715</b>	6V	MA6	1.6	<b>£31.46</b>
<b>060716</b>	12V	MA12	3.0	<b>£31.46</b>

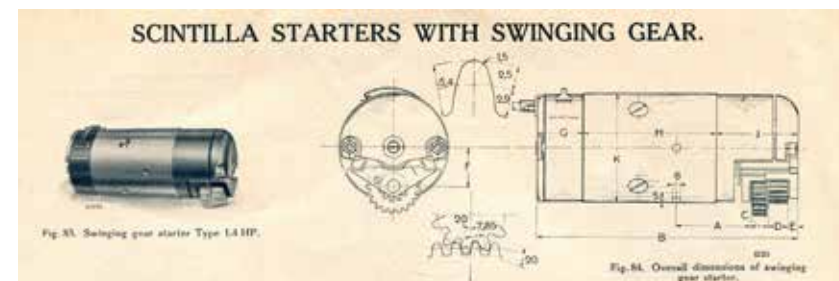



## REMAX IGNITION COILS - 6V & 12V



REMAX high quality ignition coils. Manufactured in England, offering better performance than traditional Lucas coils.

55mm diameter and oil filled. Available in either 6V or 12V, standard or sports, non-ballasted or ballast type.

\* Requires ballast resistor: 060703 - p.80.

Part No.	6V/12V	Connection	Type	Primary Resist. (Ω)	Each
ES1	6V	Acorn	Standard	1.335	£36.50
ES6	6V	Push-in	Standard	1.385	£37.74
ES4	6V	Push-in	Sports	1.4	£42.78
ES2	12V	Acorn	Standard	3.455	£36.50
ES5	12V	Push-in	Standard	2.955	£36.50
ES6B *	12V	Push-in	Ballast	1.385	£37.74
ES3	12V	Push-in	Sports	2.9	£42.78
ES4B *	12V	Push-in	Sports Ballast	1.4	£42.78

## DISTRIBUTOR/COIL ACORNS



Long acorn for use with coils.

**060802**

£1.55 each

£13.19 / 10



Short acorn for use with distributors.

**060801**

£0.76 each

£6.59 / 10

## BRASS WASHERS FOR 060801 & 060802



Brass washers for terminating HT cable when used with acorn type connectors.

**060803**

£0.30 each

£2.64 / 10

## LUCAS CONDENSORS



Lucas DCB101C condenser. (0.20 microfarad). 17.5mm diameter x 20mm long.

**061106**

£5.16



Lucas DCB104C condenser. (0.20 microfarad). 17mm diameter x 20mm long (excluding stud).

**061101**

£6.39



Lucas DCB112C condenser. (0.20 microfarad). 17mm diameter x 20mm long (excluding stud).

**061108**

£9.68



Lucas DCB121C condenser. 17mm diameter x 39mm long (excluding stud).

**061102**

£14.90



Lucas DCB203C condenser. (0.22 microfarad). 17mm diameter x 39mm long (excluding stud).

**061103**

£6.89



Lucas DCB221C condenser. (0.22 microfarad). 17mm diameter x 39mm long (excluding stud).

**061107**

£6.49



Lucas DCB703C condenser. (0.23 microfarad). 18mm diameter x 31.7mm long (excluding stud).

**061104**

£6.24



Lucas DCB752C condenser. (0.23 microfarad).

**061105**

£4.77



## BATTERY ACCESSORIES



An anti-corrosive compound which neutralises corrosion and inhibits deterioration of terminals and metal parts on or near lead acid batteries.

**072002**

**£4.64**



Battery hold down clamp, punched angle bracket 348mm and two threaded 300mm J-bolts with wing nuts. Tin plated. Adjusts to fit all popular sizes of battery.

**072401**

**£4.38**



Battery post cleaning brush, with screw on cover, for cleaning posts and terminals. Has two brushes. One for the exterior of battery posts, the other for the interior of battery clamps.

**072001**

**£11.22**



Battery removal/carry strap. Acid resistant belting, 25mm wide, with quick fix grips to fit terminal posts, and hooks for flat battery posts.

**072003**

**£28.82**



Single insulated terminal posts. Plastic base with M8 stud. Available in either **black** (070703-B) or **red** (070703-R). 150A.

**070703-B or -R**

**£5.61**



Quick release battery terminals with integral covers. Supplied as a pair (positive and negative). The terminals are secured onto the battery posts by hinging down the covers. Maximum cable 40mm<sup>2</sup>.

**070350**

**£12.20**



A plastic battery lead junction box with a hinged lid capable of 300A continuous. It has 2 x 8mm studs so that many cables can be joined, and a fixing hole enabling it to be surface mounted. Approximate dimensions 60 x 42 x 42mm.

**070701**

**£11.84**



Tool for cleaning both negative and positive battery terminals and also battery posts. Has male tapered cutter for cleaning the battery terminals and two female tapered cutters for cleaning the battery posts. Made in Germany.

**072010**

**£14.40**

## BATTERY BOXES



A good quality budget battery box with red lid which includes a hold down strap & fixings. This is the **small** size and the dimensions are as follows:  
Internal: L 270mm x W 180mm x H 200mm  
External: L 320mm x W 220mm x H 270mm

**072020**

**£28.08**

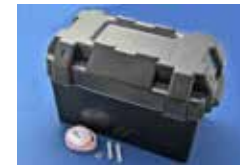

A good quality budget battery box in black which includes a hold down strap & fixings. This is the **medium** size and the dimensions are as follows:  
Internal: L 350mm x W 185mm x H 255mm  
External: L 435mm x W 245mm x H 265mm

**072021**

**£32.38**



A good quality budget battery box with yellow lid which includes an adjustable divider, hold down strap & fixings. This is the **large** size and the dimensions are as follows:  
Internal: L 400mm x W 180mm x H 260mm  
External: L 440mm x W 240mm x H 275mm

**072022**

**£36.00**

## BATTERY CLAMPS - SCREW TYPE



Made from tinned brass. Available for three different cable sizes.

To insulate, use covers 070501 - 070504 - see p.88.

Part No.	Type	Cable Size (mm <sup>2</sup> )	Approx. Cable Hole Dia.	Each
<b>070101</b>	Negative	up to 40	10mm	<b>£2.86</b>
<b>070102</b>	Positive	up to 40	10mm	<b>£2.86</b>
<b>070103</b>	Negative	up to 60	12mm	<b>£3.50</b>
<b>070104</b>	Positive	up to 60	12mm	<b>£3.50</b>
<b>070105</b>	Negative	up to 95	16mm	<b>£4.07</b>
<b>070106</b>	Positive	up to 95	16mm	<b>£4.07</b>

## BATTERY CLAMPS - SOLDER TYPE



Made from tinned brass. Available for four different cable sizes.

To insulate, use covers 070501 - 070504 - see p.88.

Part No.	Type	Cable Size (mm <sup>2</sup> )	Each
<b>070205</b>	Negative	up to 25	<b>£4.63</b>
<b>070206</b>	Positive	up to 25	<b>£4.63</b>
<b>070201</b>	Negative	up to 40	<b>£4.63</b>
<b>070202</b>	Positive	up to 40	<b>£4.63</b>
<b>070203</b>	Negative	up to 60	<b>£5.81</b>
<b>070204</b>	Positive	up to 60	<b>£5.81</b>
<b>070208</b>	Negative	up to 100	<b>£5.95</b>
<b>070207</b>	Positive	up to 100	<b>£5.95</b>

## BATTERY CLAMPS - STUD TYPE



Made from tinned brass. Stud size 8mm or 10mm dia.

To insulate, use covers 070507 & 070508 - see p.88.

Part No.	Type	Stud Size	Each
<b>070301</b>	Negative	8mm	<b>£3.55</b>
<b>070302</b>	Positive	8mm	<b>£3.55</b>
<b>070305</b>	Negative	10mm	<b>£3.55</b>
<b>070306</b>	Positive	10mm	<b>£3.55</b>

## BATTERY CLAMPS - END FEED TYPE



Suitable for crimping and soldering. These are universal and will fit both positive and negative battery poles.

To insulate, use covers 070505 & 070506 - see p.88.

Part No.	Cable Size (mm <sup>2</sup> )	Each
<b>072707</b>	20	<b>£3.23</b>
<b>072708</b>	25	<b>£3.23</b>

## BATTERY CLAMPS - FUSED TYPE



Special stud type battery clamp capable of taking compact fuses. Fuses of different sizes can be fitted ranging from 75 to 300A, enabling the battery cable leaving the clamp to be fused. The special insulated nut must be used with this clamp. The ring terminal on the end of the battery cable must have a hole diameter of 10mm to fit this nut. (Stud thread is M8).

Part No.	Type	Each
<b>070303</b>	Clamp	<b>£7.97</b>
<b>070304</b>	Nut	<b>£4.17</b>
<b>101301</b>	50A fuse	<b>£6.79</b>
<b>101302</b>	75A fuse	<b>£6.79</b>
<b>101303</b>	100A fuse	<b>£6.79</b>
<b>101304</b>	150A fuse	<b>£6.79</b>
<b>101305</b>	200A fuse	<b>£6.79</b>
<b>101306</b>	250A fuse	<b>£6.79</b>
<b>101307</b>	300A fuse	<b>£6.79</b>

## BATTERY CLAMPS - FRENCH TYPE



French style battery clamps, where the battery cable fits over the M8 stud. The process of tightening the plastic nut, clamps the cable and causes the terminal to grip the battery post.

Part No.	Type	Colour	Each
<b>070361</b>	Negative	Green	<b>£5.61</b>
<b>070360</b>	Positive	Red	<b>£5.61</b>

## BATTERY CLAMP COVERS - SCREW/SOLDER



PVC battery terminal covers for use with screw and solder type battery terminals. Available in **red** or **black**. Approx 39 x 52mm.



Type A



Type B

Part No.	Type	Colour	Each
070501	A	Black	£1.17
070502	A	Red	£1.17
070503	B	Black	£1.17
070504	B	Red	£1.17

## BATTERY CLAMP COVERS - END FEED



For use with end feed type battery clamps (072707 & 072708 - see p.86).

Part No.	Colour	Each
070505	Red	£1.17
070506	Black	£1.17

## BATTERY CLAMP COVERS - STUD



For use with stud type battery clamps (070301 & 070302 - see p.86).

Part No.	Colour	Each
070507	Black	£1.58
070508	Red	£1.58

## BATTERY CABLE CONNECTORS



These connectors are used to join battery cables. Heavy brass body with four grub screws. Supplied with heat shrinkable sleeving.

Part No.	Bore Dia. (mm)	Max. Cable Size (mm <sup>2</sup> )	Each
070601	8.0	35	£7.72
070602	9.5	40	£8.66

## BUTT SPLICE CONNECTORS



Crimp butt splices for cable joining. Made from tinned copper.

Part No.	Max. Cable Size (mm <sup>2</sup> )	Each	10
072607	2.5	£0.27	£2.24
072608	4	£0.30	£2.69
072601	6	£0.51	£4.46
072602	10	£0.58	£4.91
072603	16	£0.65	£5.60
072604	25	£0.72	£6.30
072605	35	£0.96	£8.10
072606	50	£1.01	£8.54
072609	70	£1.48	£12.61

## BATTERY CABLE TERMINALS - OPEN END



Tinned open end copper terminals suitable for crimping or soldering. **Please note that the figure given in mm<sup>2</sup> is the cross sectional area of the suitable cable and not its diameter.**

\* (Please note that the terminals for 40mm<sup>2</sup> cable are in fact 35mm<sup>2</sup> terminals. They do however fit the 40mm<sup>2</sup> cable).

Part No.	Max. Cable Size (mm <sup>2</sup> )	Stud Hole Size (mm)	Each	10
070901	10	6	£0.63	£5.29
070902	10	8	£0.66	£5.73
070903	10	10	£0.71	£6.16
070904	16	6	£0.82	£6.89
070905	16	8	£0.86	£7.23
070906	16	10	£0.89	£7.60
070907	25	6	£0.93	£7.89
070908	25	8	£0.98	£8.22
070909	25	10	£1.01	£8.51
070910	40*	6	£1.12	£9.51
070911	40*	8	£1.17	£9.98
070912	40*	10	£1.22	£10.41
070913	40*	12	£2.08	£17.71

### HOW TO CALCULATE CABLE CONDUCTOR AREA:

Area =  $\pi r^2$ , where  $\pi$  = approx. 3.142 and r = radius

If the diameter of a strand of copper is 0.30mm, the radius is half of that, ie. 0.15mm

So, for a piece of cable with 120 strands of 0.30mm diameter the calculation would be:

$$(3.142 \times 0.15^2) \times 120 = 8.48\text{mm}^2$$

## BATTERY CABLE TERMINALS - CLOSED END



Tinned closed end copper terminals suitable for crimping or soldering. **Please note that the figure given in mm<sup>2</sup> is the cross sectional area of the suitable cable and not its diameter.**

\* (Please note that the terminals for 40mm<sup>2</sup> cable are in fact 35mm<sup>2</sup> terminals. They do however fit the 40mm<sup>2</sup> cable).

Part No.	Max. Cable Size (mm <sup>2</sup> )	Stud Hole Size (mm)	Each	10
071001	6	6	£0.54	£4.55
071002	6	8	£0.54	£4.55
071029	10	5	£0.65	£5.58
071003	10	6	£0.65	£5.58
071004	10	8	£0.65	£5.58
071005	10	10	£0.66	£5.73
071006	10	12	£0.66	£5.73
071007	16	6	£0.72	£6.34
071008	16	8	£0.80	£6.75
071009	16	10	£0.80	£6.75
071010	16	12	£0.83	£7.04
071011	25	6	£0.86	£7.20
071012	25	8	£0.88	£7.48
071013	25	10	£0.91	£7.78
071014	25	12	£0.95	£8.04
071015	40*	6	£1.01	£8.51
071016	40*	8	£1.06	£8.97
071017	40*	10	£1.09	£9.36
071018	40*	12	£1.17	£9.98
071019	50	6	£1.34	£11.41
071020	50	8	£1.39	£11.89
071021	50	10	£1.43	£12.18
071022	50	12	£1.48	£12.47
071024	70	8	£1.61	£13.69
071025	70	10	£1.67	£14.14
071028	70	12	£1.71	£14.60
071027	95	10	£1.95	£16.60

## TINNED COPPER TERMINAL KIT (SMALL TERMINALS)



A kit of 96 tinned copper closed end ring terminals (with holes ranging from 5- 10mm) suitable for crimping or soldering on to cables from 6 to 25mm<sup>2</sup>. Packed into a robust plastic case with dividers.

**160130**      **£37.62**

## TINNED COPPER TERMINAL KIT (LARGE TERMINALS)



A kit of 80 tinned copper closed end ring terminals (with holes ranging from 6- 12mm) suitable for crimping or soldering on to cables from 25 to 50mm<sup>2</sup>. Packed into a robust plastic case with dividers.

**160131**      **£52.77**

## BATTERY CABLE TERMINALS - RIGHT-ANGLED



Tinned closed end copper terminals suitable for crimping or soldering. **Please note that the figure given in mm<sup>2</sup> is the cross sectional area of the suitable cable and not its diameter.**

Part No.	Max. Cable Size (mm <sup>2</sup> )	Stud Hole Size (mm)	Each	10
071201	10	6	£0.96	£8.60
071202	10	8	£0.98	£8.83
071206	16	6	£1.14	£10.31
071207	16	8	£1.14	£9.68
071209	25	6	£1.34	£11.99
071210	25	8	£1.32	£11.41
071211	25	10	£1.34	£11.99
071214	35	8	£1.61	£13.78
071215	35	10	£1.64	£14.73
071218	50	8	£2.02	£18.10
071219	50	10	£2.02	£18.10

## POWER CONNECTORS



2 pole connectors used to safely and easily connect/disconnect battery/welding leads. **Two connectors are required.** For example: one mounted on the vehicle, the other on the end of the jump start battery leads. Handles are available for use with the 175A and 350A rated connectors. Supplied with terminals. **Please note that 071502 (grey) and 071502-R (red) are not compatible (ie. they will not plug together).**

Part No.	Current Rating (A)	Max. Cable Size (mm <sup>2</sup> )	Colour	Each
071501	50	6	Grey	£9.77
071502	175	35	Grey	£14.75
071502-R	175	50	Red	£14.75
071503	350	70	Grey	£24.03

## SPARE TERMINALS & HANDLE



Terminals fit 071502 and 071502-R only. Handle fits 071502 and 071503.

Part No.	Type	Each
071505	Terminals	£5.73 / pair
071601	Handle	£9.94

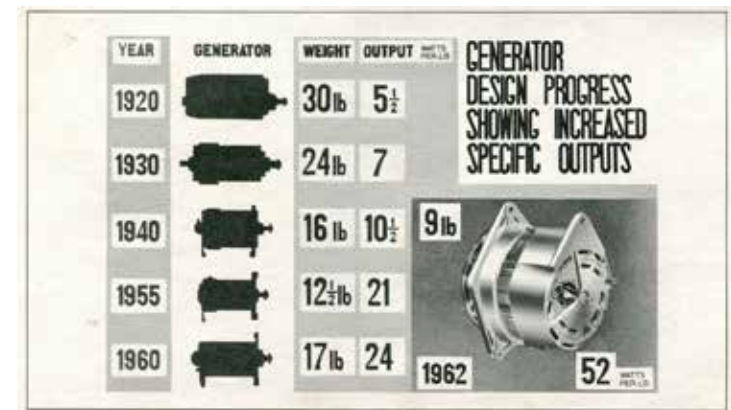



## BATTERY TERMINAL COVERS - SMALL



Push-on rubber covers for terminals to insulate open or closed end battery terminals.

As a guide, the biggest cables that can fit into the covers are as follows:

070801 - 8.5mm<sup>2</sup> (010108 or 010707)

070802 - 16mm<sup>2</sup> (010604)

070803 - 25mm<sup>2</sup> (010602)

Part No.	Max. Cable Dia. (mm)	Int. Cap Dia. (mm)	Colour	Each	10
070801	6.5	10.5	Black	£0.57	£4.80
070802-B	8	15.5	Black	£0.58	£4.91
070802-R	8	15.5	Red	£0.58	£4.91
070803	9	15.5	Black	£0.65	£5.63

## BATTERY TERMINAL COVERS - MEDIUM



Push-on rubber covers for terminals to insulate open or closed end battery terminals.

As a guide, the biggest cables that can fit into the covers are as follows:

070805 - 20mm<sup>2</sup> (010601)

070806 - 40mm<sup>2</sup> (010603)

Part No.	Max. Cable Dia. (mm)	Int. Cap Dia. (mm)	Colour	Each	10
070805-B	10	17	Black	£0.89	£7.31
070805-R	10	17	Red	£0.89	£7.31
070806-B	13.5	17	Black	£0.89	£7.31
070806-R	13.5	17	Red	£0.89	£7.31

## BATTERY TERMINAL COVERS - LARGE



Push-on PVC covers for terminals to insulate open or closed end battery terminals.

As a guide, the biggest cable that can fit into these covers is 60mm<sup>2</sup> cable (010605).

Part No.	Max. Cable Dia. (mm)	Int. Cap (mm)	Colour	Each	10
070804-B	17	25 x 38	Black	£1.12	£9.51
070804-R	17	25 x 38	Red	£1.12	£9.51

## PREFORMED BATTERY CABLES - BATTERY/RING



Preformed battery cables made from 266/0.30mm, 20mm<sup>2</sup> battery cable, 135A capacity, 8mm ring terminal. Universal battery terminal to fit either positive or negative terminal.

Part No.	Length (mm)	Each
072101	225	£11.13
072102	300	£11.52
072103	450	£13.68
072104	600	£14.09

## PREFORMED BATTERY CABLES - RING/RING



Preformed battery cables made from 37/0.90, 25mm<sup>2</sup> black cable, with 170A capacity. At each end of the cable is an 8mm ring terminal.

Part No.	Length (mm)	Each
071901	300	£7.81
071902	450	£9.24
071903	600	£10.66



## EARTH STRAPS



Tinned braided copper earth straps. Universal battery clamp (fits both negative and positive battery terminals). 130A continuous rating. 8mm bolt hole.

Part No.	Length (mm)	Each
<b>071302</b>	300	<b>£7.94</b>
<b>071303</b>	450	<b>£9.70</b>

## BONDING STRAPS



Universal flat bonding straps. Tinned copper, 100A, 24mm wide, 10mm diameter holes.

Part No.	Length (mm)	Each
<b>071401</b>	150	<b>£3.63</b>
<b>071402</b>	300	<b>£4.71</b>
<b>071403</b>	450	<b>£5.80</b>

## EARTHING BRAID



Tinned copper earthing braid, useful for making earth leads. 2 sizes available, 19mm² & 37mm².

For 010801, use ring terminals suitable for 25mm² cable.

For 010802, use ring terminals suitable for 40mm² cable.

Part No.	Cable Size (mm²)	OD (mm)	Current (A)	m
<b>010801</b>	19	7.2	130	<b>£6.71</b>
<b>010802</b>	37	11.1	260	<b>£14.51</b>

## BATTERY ISOLATOR SWITCHES



Battery isolator with removable key in the 'on' or 'off' position. 100A@24V, 500A for 5 secs. M10 studs. Comes with 2 keys. Requires 23mm panel hole and 2 x 8mm mounting holes on 90mm centres.

**071705**

**£39.76**



Spare key for 071705.

**071706**

**£7.11**



Battery isolator switch with removable key and splash proof cover and independent ignition switch to prevent engine run on in an emergency. Supplied with 3Ω resistor to suppress alternator surge spikes from damaging the electrical system when isolator switch is operated. 100A@24V, 500A for 5 seconds. M10 studs. Supplied with wiring diagram.

**071704**

**£29.68**



Spare key for 071704.

**071702**

**£2.61**



Spare resistor to suit master switch 071704. Resistor value 3.3Ω, 11W.

**071721**

**£3.47**



Isolator switch with removable key. 100A@24V, 500A for 5 sec. M8 studs. Spare key and rubber protector cap available separately. Two fixing holes 38 mm apart.

**071716**

**£9.62**



Spare key for 071716. Supplied with rubber protective cap for switch.

**071710**

**£2.64**



Rubber protector cap for 071716.

**071703**

**£1.23**



A kit of parts to facilitate the fitting of an isolator switch. Consists of isolator switch 071716, 2 x closed end ring terminals to take up to 25mm² cable, 2 x rubber covers to suit, and 1 x spare key with rubber cover.

**071716-K**

**£14.47**

## BATTERY ISOLATOR SWITCHES



Metal cased high quality isolator switch. Has the following specification: 1000A for 5 seconds 150A Continuous, 8mm mounting holes on 45mm centres. Requires 28mm panel hole (if mounted behind the panel). Waterproof to IP68. Removable key. M10 terminals. Height of cylindrical section above mounting face 47mm.

**071722**

**£46.08**



Spare key for 071722.

**071722-K**

**£16.15**



Double pole battery isolator switch. This battery isolator will break two circuits simultaneously. Removable metal knob. Rated at 125A continuously and 500A for 15 seconds. Max diameter 67mm, overall height 112mm. Has 4 x 3/8" stud connections and requires a 19mm diameter mounting hole.

**071720**

**£47.75**



High quality, metal cased isolator switch. Waterproof to SAE J1171. 300A @ 24V continuous. 1000A @ 24V for 5 seconds. Two fixing holes 45mm apart. 2 x M10 studs.

**071708**

**£37.87**



Lucas SSB103 battery isolator switch. This unit has a third terminal which connects to the case (ie earth) when the switch is switched off.

**071709**

**£67.82**



Lucas SSB106 battery isolator switch. 150A continuous current capacity. 1500A intermittent capacity. Has 3/8 Whitworth studs and requires 19.5mm mounting hole.

**071717**

**£54.99**



Lucas-style SSB106 battery isolator with fixed black handle and metal case. 120A@12V. M10 studs. Requires 19mm panel hole.

**071707**

**£18.57**

## MARINE BATTERY ISOLATOR SWITCHES



Marine battery isolator and change over switch. Quick disconnect. Can be used to select between batteries one, two, both or off. Rated at 175A@12V and 300A for 5 seconds. M10 studs.

**071713**

**£43.21**



Quick disconnect marine battery isolator with removable key and splash proof cover. Rated at 100A@24V. M10 studs. Requires 22.5mm fixing hole.

**071711**

**£30.30**



Spare key for 071711.

**071712**

**£3.11**



Marine battery isolator switch. Rated at 300A continuous (1 hr) and 1000A for 5 seconds. Max voltage 48V. Has knock out sections for battery cables. Studs are M10. 69 x 69 x 77mm. CE Approved.

**0-605-11**

**£32.09**



Marine battery isolator switch with fixed knob and padlock hole. (Can be locked in either on or off position with suitable padlock). Rated at 600A continuous (1 hr) and 2500A for 5 seconds. Max voltage 48V. Has knock out sections for battery cables. Studs are M12. 102 x 102 x 90mm. CE approved.

**0-605-12**

**£68.70**



Budget version of Durite 0-605-12 marine isolator switch. Essentially the same switch, but from a different supplier. Can be locked in either on or off position with suitable padlock. Rated at 600A continuous (1 hr) and 2500A for 5 seconds. Max voltage 48V. Has knock out sections for battery cables. Studs are M12. 102 x 102 x 90mm. Supplied with 4 x nut/bolts. CE approved.

**071723**

**£35.83**

## QUICK DISCONNECT BATTERY TERMINALS



Battery isolator switch that fits directly to the battery negative post. Has a green plastic tightening wheel for quick electrical disconnection. L=86mm, H=34mm, W=36mm.

**070401**

**£10.22**



As above with terminal bridging fuse holder (for radio, alarm and clock feeds).

**070402**

**£12.53**

## STARTER SOLENOIDS



12V Lucas replica starter solenoid with manual rubber button. Two battery terminal connections (M8 studs), 1 x 6.3mm blade switch connection.

**071801**

**£29.06**

24V version of above. Has 2 x M8 studs for battery cable terminals and 2 x 5mm studs for switch connections. (Replaces Lucas SRB321).

**071808**

**£29.06**



12V Lucas replica basic solenoid. 2 x M8 fixings for battery cable and 1 x 6.3mm blade terminal.

**071802**

**£14.75**

24V version of above. Has 2 x M8 fixings for battery cable terminals and 2 x 6.3mm blade terminals for switch connections.

**071809**

**£18.94**



12V Lucas replica basic 4 terminal solenoid. Has 2 x M8 studs for battery cable connections and 2 x 6.3mm blade terminals for switch connections.

**071810**

**£16.92**



12V Lucas replica ballast ignition solenoid. Has 2 x M8 studs for battery cable connections and 2 x 6.3mm blade terminals. One is solenoid 'trigger' feed from ignition switch and the other connects to the ignition coil. Replaces Lucas SRB333/335.

**071813**

**£16.92**



6V starter solenoid. Battery cable connection via 2 x M8 Studs. Switch connection via M5 stud. This unit needs to be earthed. Supplied mounted to bracket.

**071807**

**£28.61**

## STARTER SWITCHES



Floor mounted starter switch, that connects the two battery terminals (8mm studs) together.

**071803**

**£31.59**



Lucas starter switch SRB311 (ST18/1). 2½" diameter black fixing plate with aluminium knob. 2 x ¼" stud terminals.

**071805**

**£55.11**



Lucas SRB312 starter switch. 2 x ¼" stud terminals. Needs 10mm mounting hole.

**071804**

**£35.20**



Replica version of Lucas 76701 pull starter switch. Contact is made between the battery terminals by pulling on the pin. This is often achieved by using a cable attached to the pin and having a starter pull handle within the vehicle that pulls on this cable. Used on many MGs. Battery cable connections ¼" studs (8mm), requires 10mm diameter mounting hole.

**071812**

**£33.71**

## BUSBARS



A range of busbars having a variety of studs or screws and different ratings. Plastic bases with tin plated copper bar and stainless steel studs. Fixing holes suitable for 5mm bolts.

Part No.	Type	Current (A)	Size (mm)	Each
<b>070710</b>	4 x 5mm studs	100	36 x 104 x 23	<b>£10.86</b>
<b>070711</b>	2 x 5mm studs, 4 x 4mm screws	100	36 x 104 x 23	<b>£9.40</b>
<b>070712</b>	4 x 6mm studs	150	36 x 150 x 30	<b>£14.36</b>
<b>070713</b>	2 x 6mm studs, 10 x 4mm screws	150	36 x 150 x 30	<b>£14.66</b>



Busbar covers to suit the above.

Part No.	To Suit Part No.	Each
<b>070720</b>	070710 and 070711	<b>£6.67</b>
<b>070721</b>	070712 and 070713	<b>£7.20</b>

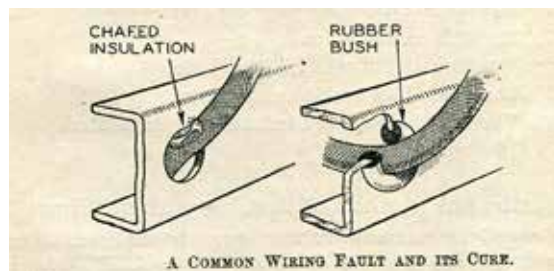

## TOGGLE SWITCHES - METAL - SINGLE POLE



Metal toggle switches with plated levers. All have 6.3mm blade terminals and require a 13mm panel hole. Current ratings in the table below are at 12V. Rubber waterproof toggle covers are available for these switches.

*In the table below, (On) means momentarily on, ie. springs back to the off position when released.*

Part No.	Type	Positions	Terminals	Current (A)	Suitable Cover	Each
<b>080101</b>	On/Off	2	2	16	080302	<b>£5.60</b>
<b>080107</b>	Off/(On)	2	2	16	080301	<b>£5.99</b>
<b>080102</b>	On/On	2	3	16	080302	<b>£5.63</b>
<b>080103</b>	On/Off/On	3	3	16	080302	<b>£5.63</b>
<b>080104</b>	On/Off/(On)	3	3	16	080302	<b>£6.27</b>
<b>080106</b>	(On)/Off/(On)	3	3	16	080302	<b>£6.27</b>
<b>080105</b>	Off/OnA/OnA+B	3	3	20	080302	<b>£11.56</b>

## WATERPROOF RUBBER COVERS

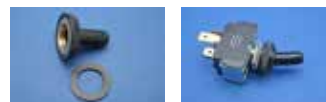

Rubber covers for metal toggle switches. Two sizes available.

Part No.	Suitable Switch	Each
<b>080301</b>	080107	<b>£1.80</b>
<b>080302</b>	080101 - 080106	<b>£1.80</b>

## TOGGLE SWITCHES - METAL - DOUBLE POLE



Metal toggle switches with plated levers. All have 6.3mm blade terminals and require a 13mm panel hole. Current ratings 16A at 12V. Rubber waterproof toggle covers are available for these switches, part number 080302 (above).

Part No.	Type	Positions	Terminals	Current (A)	Each
<b>080201</b>	On/Off	2	4	16	<b>£7.51</b>
<b>080202</b>	On/On	2	6	16	<b>£8.18</b>
<b>080203</b>	On/Off/On	3	6	16	<b>£8.36</b>

## TOGGLE SWITCHES - SPLASH PROOF



Single pole switches with rubber sealing gaiters over nickel plated brass levers. 6.3mm blade terminals. Require 13mm panel hole. 10A@12V.

*In the table below, (On) means momentarily on, ie. springs back to the off position when released.*

Part No.	Type	Positions	Terminals	Current (A)	Each
081801	On/Off	2	2	10	£10.73
081802	On/Off/On	3	3	10	£12.22
081803	On/Off/(On)	3	3	10	£11.93
081804	(On)/Off/(On)	3	3	10	£11.93

## TOGGLE SWITCHES - LUCAS



Original Lucas items (\*except 081605, which is a replica item). Connections via 6.3mm blade terminals. All require 13mm panel hole. Will fit panels up to 3mm thick.

*In the table below, (On) means momentarily on, ie. springs back to the off position when released.*

Part No.	Type	Positions	Lucas Part No.	Current (A)	Each
081601	On/Off	2	SPB200	5	£12.44
081605 *	On/Off	2	Rep SPB200	5	£8.94
081602	On/Off/On	3	31743	10	£21.59
081603	On/On	2	31780	10	£19.68
081604	Off/OnA/OnA+B	3	31788	10	£15.97
081606	Off/On/On	3	35927	10	£22.11
081607	On/On	2	34889	10	£18.60
081608	Off/(On)	2	SPB365	10	£5.23

## TOGGLE SWITCHES - LED



Nickel plated on/off single pole toggle switches with 12/24V LED indicator at the end of the toggle. Available with **blue, green, red** or **amber** LED. Connections via 6.3mm blade terminals. Requires 13mm panel hole. 25A @ 12V dc.

Part No.	LED Colour	Positions	Terminals	Current (A)	Each
082201	Blue	2	3	25	£6.27
082202	Green	2	3	25	£6.27
082203	Red	2	3	25	£6.27
082204	Amber	2	3	25	£6.27

## TOGGLE SWITCHES - ALUMINIUM/PLASTIC



Toggle switches with turned aluminium levers. Single pole. Require 13mm panel hole. Maximum panel thickness 2.5mm. Screw connections.

Part No.	Type	Positions	Terminals	Current (A)	Each
081701	On/Off	2	2	6	£7.33
081702	On/Off/On	3	3	6	£5.75



## TOGGLE SWITCHES - MINIATURE



Miniature toggle switches with metal lever, requiring 6mm panel hole. Solder connections. 6A@12V, 3A@24V.

Part No.	Type	Positions	Terminals	Each
<b>082301</b>	On/Off	2	2	<b>£3.49</b>
<b>082302</b>	On/On	2	3	<b>£3.49</b>
<b>082303</b>	On/Off/On	3	3	<b>£3.49</b>

## TOGGLE SWITCHES - PLASTIC



Toggle switches with black plastic levers. 6.3mm blade terminals. Require 13mm panel hole. All single pole. Current ratings below are at 12V.

*In the table below, (On) means momentarily on, ie. springs back to the off position when released.*

Part No.	Type	Positions	Terminals	Current (A)	Each
<b>080401</b>	On/Off	2	2	10	<b>£1.02</b>
<b>080402</b>	(On)/Off	2	2	16	<b>£1.30</b>
<b>080403</b>	On/On	2	3	5	<b>£1.30</b>
<b>080404</b>	On/Off/On	3	3	10	<b>£5.66</b>

## TOGGLE SWITCH - LONG LEVER PLASTIC



On/Off switch with long black lever (75mm long) with two 6.3mm blade terminals. Requires 12.5mm panel hole. 10A@12V.

**080406**  
**£3.54**

## TOGGLE SWITCHES - ILLUMINATED PLASTIC



On/Off toggle switches which illuminate when switched on. 10A@12V. Require 13mm panel hole. 2 x 6.3mm blade terminals (further blade terminal for bulb). Available in **blue**, **green** or **red**.

Part No.	Colour	Positions	Terminals	Current (A)	Each
<b>080501-U</b>	Blue	2	2	10	<b>£2.24</b>
<b>080501-G</b>	Green	2	2	10	<b>£2.24</b>
<b>080501-R</b>	Red	2	2	10	<b>£2.24</b>

## TOGGLE SWITCH SAFETY GUARDS



Toggle switch safety guard. Moulded plastic and spring loaded to cover toggle. Prevents accidental switch use. Fits most 13mm diameter toggle switches. Available in 4 colours.

Part No.	Colour	Each
<b>082002</b>	Red	<b>£3.91</b>
<b>082003</b>	Blue	<b>£3.91</b>
<b>082004</b>	Green	<b>£3.91</b>
<b>082005</b>	Yellow	<b>£3.91</b>

## TOGGLE SWITCH FASCIA



Simply place under the nut that secures the switch. A tag on the fascia ensures it is the correct way up. (To fit all toggle switches except miniature switches).

**082001**  
**£0.97**

## SWITCH PANEL MOUNTS

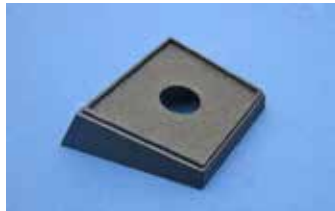

Made from black plastic. Both switch panels have 13mm mounting holes.

Part No.	Type	Max. Dimensions (mm)	Each
080603	1 hole	55 x 47	£0.93
080604	2 holes	55 x 47	£1.18

## SWITCH PANEL ASSEMBLY



Chrome plated switch panel featuring battery isolator switch with removable key (10mm stud connections), 12V red warning lamp, rubber push starter button. Panel size approximately 135mm x 65mm.

**080609**

**£16.84**

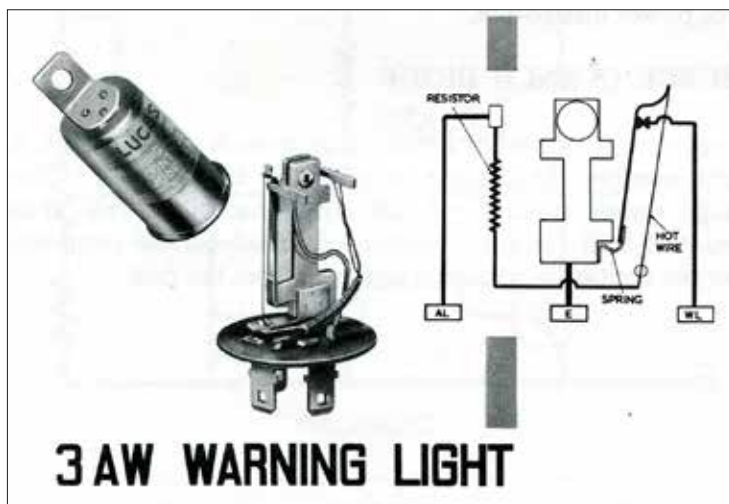

## PUSH/PULL SWITCHES



Simple push/pull switch. On/off. Black knob. 2 x screw terminals. 25A@12V. 8mm fixing hole. Maximum panel thickness 4mm. Shaft has M4 thread to hold on knob.

**080701**

**£2.21**



Simple push/pull switch. On/off. Pull to make the circuit. Black knob. 2 x screw terminals. 25A@12V. 8mm fixing hole. Maximum panel thickness 12mm. Knob unscrews from shaft. (M4 thread).

**080707**

**£3.42**



3 position push/pull heavy duty switch. Off/ On A/On A+B. Suitable for side/headlamps. Screw terminals. 10A@12V. 13mm fixing hole. Knob screws on (M5 thread), 6mm diameter shaft.

**080702**

**£11.30**



Illuminated on/off push/pull switch. Only illuminated when switched on. 6.3 mm blade terminals. 10A@12V. 12mm fixing hole. Max panel thickness 3mm. 3rd terminal is earth for the bulb. Supplied and fitted with BA7s 12V bulb. Available with **green, red, clear** or **amber** lens.

Part No.	Colour	Each
080703-A	Amber	£11.13
080703-R	Red	£11.13
080703-C	Clear	£11.13
080703-G	Green	£11.13



Lucas SPB104. Simple push/pull switch. On/off. 2 Screw Terminals. Requires 10mm panel hole. Maximum panel thickness 13mm.

**080708**

**£16.84**



Lucas 34477 3 position push/pull switch. Has ¼" hexagonal shaft with spring loaded button to hold on knob, and 6 x 6.3mm blade terminals. Requires 14mm panel hole. Maximum panel thickness 3mm.

**LUCAS 34477**

**£27.69**

## PUSH BUTTON SWITCHES



Black knob, metal housing. 10A@12V. 2 screw terminals. 22 mm fixing hole.

**080802**

**£7.62**



Black knob, plastic housing. 12.5A@12V. 2 screw terminals. 22 mm fixing hole.

**080801**

**£5.60**



Black knob, plastic housing. Two screw terminals. 15.5mm fixing hole. 7A@12V.

**080812**

**£6.09**



Black knob, plastic housing (20mm diameter). Two screw terminals. Requires 14mm fixing hole. 10@12V.

**080818**

**£10.44**



Heavy duty waterproof push button horn switch. Yellow button with horn logo on black silicon cover. 2 x 6.3mm blade terminals.

**080821**

**£28.00**



Water-proof push button switch. Has black rubber cover and requires 22.5mm panel hole. Maximum panel thickness 5mm. 2 x screw terminals. 16A@12V.

**080806**

**£7.58**



Genuine Lucas SPB105 panel/kill switch SS5 (31071). Chrome plated body with black push button. Hole diameter 20mm. 2 x screw type wire connections.

**080819**

**£14.53**



Lucas SPB106 panel switch. Chrome plated body with black push button. Requires 20mm panel hole. Maximum panel thickness 3mm. 2 x 6.3mm blade terminals. 11A @ 12V.

**080807**

**£24.63**



Replica version of Lucas SPB106 panel switch. Chrome plated body with black push button. Requires 20mm panel hole. Maximum panel thickness 3mm. 2 x 6.3mm blade terminals. 11A @ 12V.

**080817**

**£14.61**



Lucas SPB160 horn push. Surface mounted, 2 x screw connections. Approximate button diameter 38mm

**080808**

**£13.43**



A miniature latching push on/push off switch. (Push once for on, push again for off). Requires a 7mm panel hole. Max panel thickness 3mm. Solder connections.

**080820**

**£5.66**



Push/push button switch. Metal button, metal housing. When pushed on, it remains on until pushed again. 13mm panel hole. 2 x 6.3mm blade terminals. 6A@12V DC.

**080813**

**£15.59**



Red plastic button and aluminium body. 2 x 6.3mm blade terminals. Requires 22mm panel hole.

**080815**

**£8.94**

contd...

## PUSH BUTTON SWITCHES (contd)



Stainless steel button with nickel plated brass body. Screw terminals. Requires 19mm panel hole. 6A @ 12V DC.

**080814**  
**£5.78**



Latching push button switches, available in black or with LED illuminated buttons in different colours. On/off, push-push single pole switch. Push once for on, push again for off. 12/24 volt LED indicator. 4.8mm blade terminals. Snap fits into 20mm diameter panel hole, 3mm max panel thickness. 24mm diameter x 33mm (including terminals). 10 amp at 24 volts dc rating. IP56 rated.

Part No.	Colour	Each
<b>0-690-54</b>	Green LED	<b>£4.96</b>
<b>0-690-55</b>	Red LED	<b>£4.96</b>
<b>0-690-60</b>	Yellow LED	<b>£4.96</b>
<b>0-690-51</b>	Black	<b>£4.96</b>

## INDICATOR SWITCHES



Lucas SPB120 indicator switch. White plastic with integral red warning lamp. For mounting on dashboard surface. 46mm between mounting hole centres. Supplied fitted with a 2.2W MES bulb. MES replacement bulbs are also available - see p.164.

**080908**  
**£72.77**



As above, but in black.

**080909**  
**£72.77**



Lucas SQB118 Column Switch. A useful universal switch having the following functions: 1. Indicator switch, by moving the stalk up/down. 2. Dip switch, by moving the column front/back. Bracket to fit 30mm column. As fitted to various 1970's MG's etc.

**LUCAS SQB118**  
**£53.07**



Lucas SQB119 column switch. Has the following functions: 1. Indicator switch, by moving the stalk up/down. 2. Dip switch, by moving the column front/back. 3. Horn push on end of stalk. As fitted to many Morgans and Triumph cars of the 1970s and 80s.

**LUCAS SQB119**  
**£52.27**



Lucas SQB128 column switch. Has the following functions: 1. Indicator switch, by moving the stalk up/down. 2. Dip switch, by moving the column front/back. 3. Horn push on end of stalk. Bracket to fit 38mm column. As fitted to various Range Rovers etc.

**LUCAS SQB128**  
**£50.32**



Metal toggle switch with plated lever. 6.3mm blade terminals. Requires 13mm panel hole. 16A@12V.

**080103**  
**£5.63**



Toggle switch. Black plastic knob, with 3 screw terminals. 5A@12V. 13mm fixing hole. 3 position, centre off.

**080901**  
**£3.73**



Rotary switch with black plastic lever and screw terminals. Requires 27mm panel hole. 6A@12V. (Matches switch 081004 - p.119).

**080905**  
**£15.68**



Rotary switch with illuminated green plastic lever and screw terminals. Requires 27mm panel hole. 6A@12V. (Matches switch 081004 - p.119). Spare bulbs available in 6 or 12V - p.179.

**080902**  
**£18.29**

## INDICATOR SWITCHES (contd)



Old style rotary switch suitable for use as an indicator switch. Has 2 independent on/off/on switches, each with three terminals, so can also be used to control warning lights/buzzers or trafficators at the same time as indicating. Requires 14mm panel hole. Maximum body diameter 41mm. Body depth excluding terminals 24mm. Connection via 6 x 6.3mm blade terminals.

**080911**

**£12.59**



Illuminated steering column mounted switch. 110mm stalk. Mounts on columns up to 40mm dia. 16A@12V. Supplied with bulb and wiring diagram. Spare 12V bulbs (LES) available - p.163.

**080903**

**£29.99**



Non-illuminated steering column mounted switch with black knob. 110mm stalk. Mounts on columns up to 40mm dia. 16A@12V.

**080904**

**£26.08**



Toggle switch with turned aluminium lever. Single pole. Requires 13mm panel hole. Maximum panel thickness 2.5mm. Screw terminals. 6A@12V.

**081702**

**£5.75**



3 position toggle switch with illuminated large green lever. Requires 18.5mm panel hole. Screw terminals. Supplied with 12V bulb. Spare bulbs (LES) available - p.163.

**080907**

**£16.47**



Clockwork indicator switch that self cancels. When the switch is turned in either direction, it causes a pair of contacts within the switch to make and break for approximately 20 seconds, and then stops. The switch has a feed in, a fuse holder to protect the switch and the indicators (takes a continental type fuse - p.144), a warning lamp terminal, and connections for left and right indicators. Can be used on 6V, 12V and 24V systems as no flasher unit is required. Can also be used with incandescent bulbs or LEDs. Requires a 12mm diameter mounting hole and is approximately 45mm x 55mm x 25mm in size. Max panel thickness 3mm. Knob can be re-positioned at 90° increments.

**080912**

**£82.96**

### 6V INDICATOR KIT WITHOUT LAMPS



This 6V kit includes all the parts you need (except the lamps) to fit indicators to any vehicle. Includes 20m twin core cable, flasher relay, dashboard switch, warning light and bracket, crimp terminals and wiring diagram.

**The 6V system will only work on negative earth applications.**

Kit requires the addition of 4 x 21W indicator lamps.

**170803**

**£34.49**

### 12V INDICATOR KIT WITHOUT LAMPS



This 12V kit includes all the parts you need (except the lamps) to fit indicators to any vehicle. Includes 20m twin core cable, flasher relay, dashboard switch, warning light and bracket, crimp terminals and wiring diagram.

**The 12V system will work on both negative and positive earth vehicles.**

Kit requires the addition of 4 x 21W indicator lamps.

**170804**

**£32.85**

#### YOU MAY ALSO BE INTERESTED IN:

- 12V LED Indicator Kit- overleaf



## 12V LED INDICATOR KIT



A complete kit of parts to enable you to fit indicators to any 12V vehicle (+ve or -ve earth). Includes 4 x Rubbolite lamps fitted with LED bulbs, 20m twin core cable, flasher relay, dashboard switch, warning light and bracket, crimp terminals and wiring diagram. The power taken for this kit is only approximately 5W (0.3A), so it is ideal for cars with limited or no charging systems and the LED bulbs are extremely long-lasting.

**170805**

**£123.82**

## HEAD/FOG LAMP RELAY KIT



A kit of parts to allow headlamps or fog lamps to be switched via a relay. This kit can be used to upgrade cars that do not have a relay in the circuit or be used to simply add fog lamps for example. The kit contains: 30A fused relay, relay connection socket, nickel plated toggle switch, switch bracket, 4 lengths of cable (1 x 5m, 3 x 1m), electrical terminals.

**170950**

**£15.23**

## HAZARD SWITCH KIT - STANDARD



A kit of parts to enable you to convert existing 12V indicators to hazards at the flick of a switch. Kit includes flasher relay, warning lamp, switch, bracket, crimp terminals and wiring diagram. Only available in 12V. For use with **standard bulbs**.

**170902**

**£23.52**

## HAZARD SWITCH KIT - LED



A kit of parts to enable you to convert existing 12V indicators to hazards at the flick of a switch. Kit includes flasher relay, warning lamp, switch, bracket, crimp terminals and wiring diagram. Only available in 12V. For use with **LED-type bulbs**.

**170903**

**£32.83**

## HAZARD SWITCHES



Rocker hazard kit. Contains an illuminated rocker hazard switch combined with a hazard relay fixed on a common bracket, for mounting on the bottom surface of a dashboard etc. It is prewired and simply needs a 12V power supply and connection to the four vehicle indicators. Negative or positive earth. (To make this unit work on positive earth, the two connections on the relay need to be reversed).

**081905**

**£14.66**



Rocker type hazard switch. Fits 37 x 18mm aperture. Non illuminated. 7 x 4.8mm blade connections. Supplied with wiring diagram.

**081904**

**£10.42**



Lucas 39665 hazard switch, as fitted to many 1970s Triumphs (TR6, Spitfire etc). Connection via 4.8mm blade terminals. Requires panel hole of 28 x 44mm.

**LUCAS 39665**

**£36.50**



Genuine Lucas SFB300 hazard kit. Includes hazard flasher relay, switch (with illuminated knob) and mounting bracket to enable hazard lights to be easily fitted to any vehicle with existing indicators. Suitable for 12V vehicles. For use on either negative or positive earth vehicles.

**081903**

**£48.68**



Panel mounted push on hazard switch, with illuminated button. Requires 30mm panel hole. 6.3mm blade connections. Useful connecting socket available (below). Supplied with wiring diagram.

**081901**

**£28.00**



Connector plug for item 081901, includes terminals (7 x 050203).

**081902**

**£2.27**

## DOOR SWITCHES



Metal universal door switch. Single 6.3mm blade terminal (circuit completes through switch body). Plunger length 4.5mm, 22mm between fixing holes.

**081504**

**£6.87**



Plastic universal door switch. Single 6.3mm blade terminal (circuit completes through switch body). Centre distance between plunger and fixing screw 10-15mm. Plunger length 0-20mm and is self setting first time door is shut.

**081501**

**£6.00**

## ROTARY SWITCHES



Genuine Lucas PLC5 ignition and lighting switch. As fitted to numerous Classic motorcycles from 1930s to 1950s. Requires 53mm diameter hole and secures in place with clip. Screw type wire connections, and supplied with 2 keys. OEM: LU34057, PLC5.

**081140**

**£85.86**



Genuine Lucas PLC6 ignition/switch. OFF-SIDE-HEAD, requires 53mm diameter hole and secures in place with clip. Screw type wire connections, and supplied with 2 keys. OEM: LU34055, PLC6.

**081141**

**£85.86**



On/off, 2 position, water resistant, illuminated rotary switch. Comes complete with 3 different coloured lenses (red, amber, green) and bulb. Black knob. 15A@12V. Fixing hole 13mm. 6.3mm blade terminals.

**081001**

**£15.23**



Off/OnA/OnA+B/OnA+C, 4 position, water resistant, rotary switch. Black knob. 15A@12V. Fixing hole 13mm. 6.3mm blade terminals. 7mm hexagonal shaft with removable knob.

**081002**

**£15.30**



Off/OnA/OnA+B. 3 position water resistant rotary switch. Black knob. 29A@12V. 6.3mm blade terminals. 13mm fixing hole. Suitable for light switch off/side/head.

**081003**

**£17.56**



Connector plug for rotary switches 081002 and 081003. Supplied with terminals.

**081006**

**£2.21**



On/off, 2 position, water resistant rotary switch. Black knob. 15A @ 12V. Fixing hole 13mm. 6.3mm blade terminals.

**081005**

**£11.03**



Splashproof (on)/off/(on) 3 position rotary switch, spring loaded to centre off position. The knob can be turned either left or right, but when released returns to the central off position. Requires 12mm fixing hole. Max panel thickness 11mm. Knob fits onto 7mm hexagonal shaft. 15A @ 12V rating.

**081013**

**£11.33**



Off/OnA/OnA+B/OnA+C. 4 position switch with black plastic lever and screw terminals. Requires 27mm panel hole. 11A@12V. (Matches switch 080905 - see p.113).

**081004**

**£20.60**



Replica Lucas 41SA lighting switch. As fitted to many 1960s motorcycles. 3 positions. Hole diameter: 20mm. Maximum panel thickness 3mm. Screw type wire connections. OEM: 41SA, LU31784

**081010**

**£29.07**



Lucas rotary 31356 switch. Requires a 20mm diameter panel hole. Maximum panel thickness 5mm.

**081009**

**£31.21**

## KEY SWITCHES - LUCAS



Lucas 4 position key switch (LU30552). Has 4 positions: Park/Off/Ignition/Ignition & Lights. Requires a 20mm panel hole. Connection via 6.3mm blade terminals. Replaces LU30552, 99-7055, 54531899. **Requires barrel and key set (081130 or 081131), which needs to be bought separately - see below.**

**LUCAS 30552**

**£30.83**



Lucas 128SA 35288 4 position key switch: Off/Aux & Ign/Aux, Ign & Heater/Ign, Heater & Start. Supplied as body only. Positions 3 and 4 are sprung loaded, so that when released, the key will return to position 2. Connection by 6.3mm and 9.5mm spade terminals. Requires 19.6mm dia. mounting hole. **Requires barrel and key set (081130 or 081131), which needs to be bought separately - see below.**

**LUCAS 35288**

**£37.86**



Lucas 31973 47SA Key Switch. 3 Positions: Off/Ignition/Start. Position 3 is sprung loaded, so that when released the key will return to position 2. Connection by 6.3mm spade terminals. **Requires barrel and key set (081130 or 081131), which needs to be bought separately - see below.**

**081120**

**£21.98**



Lucas 54316731. 'Unique' barrel and key set.

**081130**

**£7.25**

Lucas 54316732. Barrel and key set that can be operated using the same key as other 54316732 lock sets. Handy if you want to be able to have one key that will operate many different locks.

**081131**

**£7.25**



Lucas 47SA key switch. Aux/Off/Ign/Start. **Supplied complete with barrel and keys (081130).** Length (inc. terminals): 57mm. Diameter: 35mm.

**081121**

**£27.09**

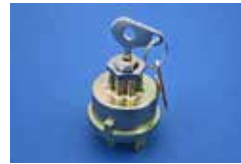

Lucas 128SA 35327 Key Switch. 4 Position switch: Off/Aux & Alt/Aux & Heater/Aux, Heater & Start. Connection by 6.3mm and 9.5mm spade terminals. Supplied with 2 keys. Spare key also available- see below.

**081110**

**£37.84**



Lucas 128SA 35670 Key Switch. 4 Position switch: Off/Aux/Aux & Heater/Aux, Heater & Start. Positions 3 and 4 are sprung loaded, so that when released the key will return to position 2. Connection by 6.3mm and 9.5mm spade terminals. Will fit either 19.6mm hole or 16mm hole (stepped mounting). Supplied with key, but spare key also available separately- see below.

**LUCAS 35670**

**£25.65**



Spare key for the Lucas 128SA switches that take the flat type of key.

**LUCAS 54324157**

**£4.11**



Lucas PLC5 ignition and lighting switch. As fitted to numerous Classic motorcycles from 1930s to 1950s. Requires 53mm diameter hole and secures in place with clip. Screw type wire connections, and supplied with 2 keys. OEM: LU34057, PLC5.

**081140**

**£85.86**



Lucas PLC6 ignition/switch. OFF-SIDE-HEAD, requires 53mm diameter hole and secures in place with clip. Screw type wire connections, and supplied with 2 keys.OEM: LU34055, PLC6.

**081141**

**£85.86**



Lucas SSB307 key switch as fitted to steering locks fitted in MGBs and Midgets from 1970 onwards.

**LUCAS SSB307**

**£18.25**

## KEY SWITCH - BOSCH



Bosch key switch (0342311004) Off/Ign/Start(momentary). 22mm fixing hole, supplied with 2 keys. 3 x 6.3mm blade terminals. Maximum panel thickness 10mm. OEM: 057 550 65

**081150**

**£39.31**

## KEY SWITCHES



2 position key switch: Off/On. 3 terminals (1 feed in, 2 out), 18mm fixing hole, supplied with 2 keys. 6.3mm blade terminals. Max panel thickness: 12mm.

**081101**

**£24.64**



3 position key switch: Off/Ign/Start. 5 terminals, 18.5mm fixing hole, supplied with 2 keys. 6.3mm blade terminals. Maximum panel thickness 12mm. Length (incl. terminals): 65mm, Diameter: 30mm.

**081102**

**£31.50**



4 position key switch: Off/Aux/Ign/Start. 4 terminals, 18.5mm fixing hole, supplied with 2 keys. 6.3mm blade terminals. Position 4 is sprung loaded, so that when released the key will return to position 3.

**081103**

**£31.13**



Spare key for switches 081101, 081102 and 081103.

**081107**

**£5.01**



6 position key switch: Parking (side)/Off/Ign/Ign & Side/Ign, Side & Dip/Ign, Side & Main. 7 terminals, fixing hole 26.5mm. Supplied with 2 keys. 9.5mm & 6.3mm blade terminals. Manufactured in Germany.

**081104**

**£36.25**



Simple on/off key switch. Key can be removed in either the off or on position. 6A @ 12V. Requires 19mm mounting hole.

**081108**

**£11.16**



2 position key switch: On/Off. Double pole switch with removable metal key and 6.3mm blade terminals. (The key is only removable when in the off position). Requires 12mm panel hole. 20A@12V.

**081105**

**£67.60**



Spare key for switch 081105.

**081106**

**£3.49**

## DIP SWITCHES



Change over, foot operated dip switch. Screw terminals.

**081301**

**£13.69**



Lucas 31284 foot operated dip switch. Connection via 3 x screw terminals.

**081303**

**£32.36**



Lucas SPB296 dip switch. 6.3mm blade terminals.

**081304**

**£14.58**



Lucas 31482 dip switch with round lever, suitable for 7/8" diameter handlebars. Has solder connections.

**081305**

**£25.76**



# ROCKER SWITCHES



Rocker switch for operating electric windows or an electric aerial. Switch only operates when pressed, ie: it returns to position shown in picture on release. Contains 2 independent change over switches. Connection via 5 x 4.8mm blade terminals. To fit an aperture 37mm x 18mm.

<b>081241</b>
<b>£5.73</b>



Rocker switch for operating electric windows. Switch only operates when pressed, ie: returns to position shown in pictures on release. Illuminated by the side light circuit and will fit a 20mm wide x 36mm long slot. 20A @ 12V, 12V LED. Supplied with wiring harness.

<b>081240</b>
<b>£4.95</b>



On/Off rocker switch - 4.8mm blade terminals. 30 x 11mm. Snaps into panel hole 19.5 x 13mm. 10A@12V.

<b>081202</b>
<b>£2.54</b>



On/off rocker switch with fluorescent indicator. 6.3mm blade terminals. Snaps into panel hole 30 x 11mm. 16A@12V.

<b>081203</b>
<b>£2.60</b>



On/off rocker switch. 2 x 6.3mm blade terminals. Case size 33 x 19mm. 10A@12V. 12.5mm fixing hole.

<b>081201</b>
<b>£2.58</b>



On/off, illuminated. 3 x 6.3mm blade terminals. Case size 33 x 19mm. 10A@12v. 12.5mm fixing hole. Available in **blue, green, red** or **amber**.

Part No.	Colour	Each
<b>081206-A</b>	Amber	<b>£2.77</b>
<b>081206-G</b>	Green	<b>£2.77</b>
<b>081206-R</b>	Red	<b>£2.77</b>
<b>081206-U</b>	Blue	<b>£2.77</b>



On/off rocker switch. 4.8mm blade terminals. Snaps into 20mm dia. panel hole. 10A@12V.

<b>081204</b>
<b>£2.58</b>



Lucas on/off rocker switch (SPB350) with LED indication for on and 4.8mm blade terminals. Snaps into 20mm dia. panel hole. 10A@12V.

<b>081205</b>
<b>£5.07</b>



Illuminated rocker switch. On/off. 4.8mm blade terminals. Snaps into 20mm dia. panel hole. 10A@12V. Available in **red** or **amber**.

Part No.	Colour	Each
<b>081230-A</b>	Amber	<b>£3.91</b>
<b>081230-R</b>	Red	<b>£3.91</b>

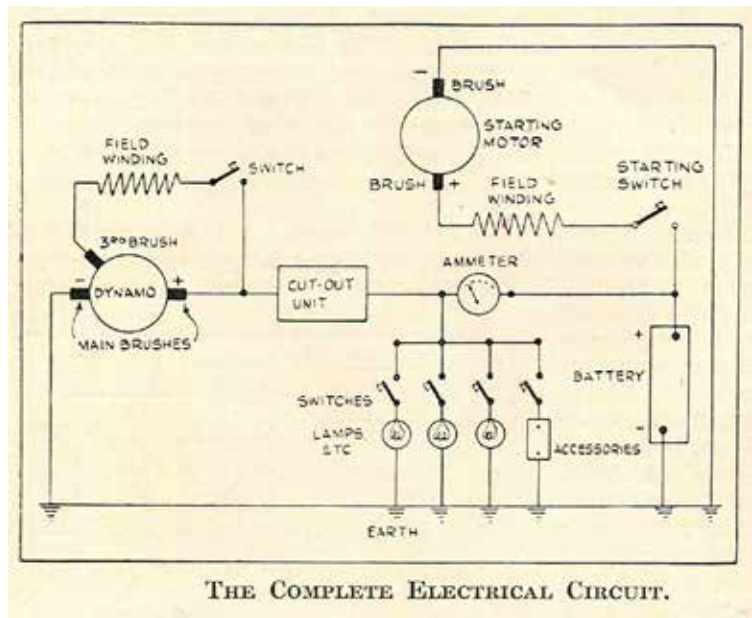



## LUCAS RHEOSTATS



Lucas 78405 rheostat. 0-15Ω. Suitable for controlling panel lights. Has a hexagonal shaft. 2 x 6.3mm blade connections. Knob available separately - see below.

**083001**

**£35.89**



Lucas 78384 rheostat. 0-15Ω. Suitable for controlling the speed of a heater. Has a hexagonal shaft. 2 x 6.3mm blade connections. Knob available separately - see below.

**083003**

**£63.67**



Knob to fit 083001 and 083003 (above).

**083002**

**£12.13**

## BRAKE LIGHT SWITCHES - MECHANICAL



Spring-loaded plunger. Can be pushed or pulled (switch closed at rest). Small hole in plunger shaft for attaching pulling wire if required. Rubber cover to protect terminals available separately - see below.

**081402**

**£6.04**



Switch with spring and clamp. Can be mounted on a flat surface or clamped to a tube (up to 25mm dia). Makes contact when spring is pulled. Rubber cover to protect terminals available separately - see below.

**081403**

**£11.43**



Switch with spring and hook. Makes contact when spring is pulled. Rubber cover to protect terminals available separately - see below.

**081401**

**£11.75**



Rubber cover for 081401, 081402 & 081403. Protects terminals from ingress of moisture, etc.

**081404**

**£2.77**



Lucas SMB485 mechanical plunger (normally open) switch with  $\frac{3}{8}$ " x 18 UNC fixing thread. Contacts are normally open until the plunger is depressed, and then they close. Connection via 2 x 6.3mm blade terminals.

**081415**

**£14.47**



Mechanical plunger switch with M12 x 1.0 fixing thread. Contacts are normally closed until the plunger is depressed, and then they break. 2 x 6.3mm blade terminals. Thread length 18mm. Supplied with two fixing nuts.

**081409**

**£8.69**



Plunger switch with M10 x 1.25 fixing thread and two pairs of contacts. When plunger is pressed one pair make and the other pair break. 4 x 6.3mm blade terminals. Overall length: 72mm. Thread length: 25mm. Thread diameter: 10mm.

**081414**

**£15.79**



Replica Lucas SMB420 mechanical plunger switch (normally open).  $\frac{3}{8}$ " x 24 UNF fixing thread. Contacts are normally open until the plunger is depressed, and then they close. Connection via 2 x 6.3mm blade terminals. Manufactured by Pride. Overall length: 50mm. Thread length: 20mm. Thread diameter: 9.4mm.

**081413**

**£15.04**

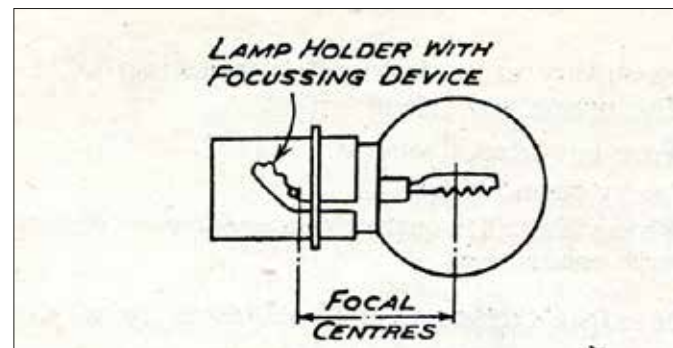

## BRAKE LIGHT SWITCHES - HYDRAULIC



Replaces Lucas SMB423.  $\frac{1}{8}$ " x 27NPTF fixing thread. Connection via 2 x 6.3mm blade terminals.

**081405**  
**£14.78**



$\frac{1}{8}$ " x 27NPTF fixing thread. Connection via 2 x screw terminals.

**081411**  
**£13.41**



Replaces Lucas SPB401.  $\frac{3}{8}$ " x 24UNF fixing thread. Connection via 2 x 6.3mm blade terminals.

**081406**  
**£14.78**



Replaces Lucas SMB426. M10 x 1 fixing thread. Connection via 2 x 6.3mm blade terminals.

**081407**  
**£14.78**

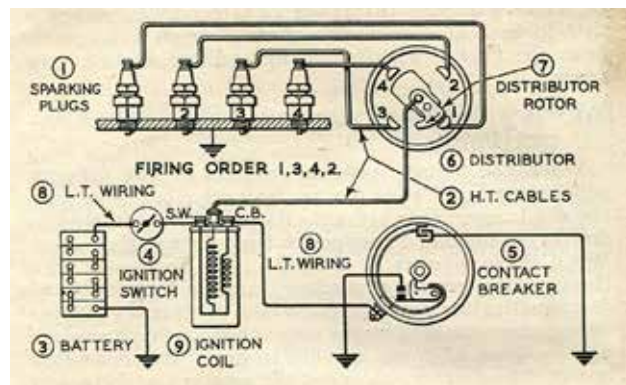

## RELAYS - GENERAL - 6V



**Make and break.** 20A @ 6V. 4 x 6.3mm blade terminals. With mounting lug. (B type pin configuration). Suitable relay sockets are 140301, 140303, 140304 & 140305 - see p.137.

**140217**  
**£8.98**



**Fused make and break relay.** 30A @ 6V. 4 x 6.3mm blade terminals. Metal bracket can be removed if necessary. B type pin configuration. Suitable relay sockets are 140301, 140303 & 140305 - see p.137. **NB. This relay will not fit into relay box 140304.**

**140218**  
**£10.42**



**Change over.** 20/30A. 5 Terminals (6.3mm blade). (B type pin configuration). Removable metal bracket. Suitable relay sockets are 140301, 140303, 140304 & 140305 - see p.137.

**140210**  
**£14.89**

### YOU MAY ALSO BE INTERESTED IN:

- 6V Flasher Units - p.139

## RELAYS - GENERAL - 12V



**Make and break.** 40A, 4 terminals (6.3mm blade, B type pin configuration), with removable bracket. Suitable relay sockets are 140301, 140303, 140304 & 140305 - see p.139.

**140201**  
**£3.45 / each**  
**£31.08 / 10**



**Make and break with diode.** 40A, 4 terminals (6.3mm blade, B type pin configuration), with removable bracket. Has internal diode across the the coil connections (85 & 86) to reduce the voltage spike across these terminals when the coil is de-energised. Suitable relay sockets are 140301, 140303, 140304 & 140305 - see p.139.

**140250**  
**£3.91 / each**  
**£35.08 / 10**

contd...

## RELAYS - GENERAL - 12V (contd)



**Fused make and break.** 30A. 4 x 6.3mm blade terminals. Suitable relay sockets are 140301 & 140303 - see p.137. (B type pin configuration). **NB: this relay will not fit into relay box 140304.**

**140202**

**£7.02 / each**

**£63.19 / 10**



**Double make and break.** 2 x 15A. 5 terminals (6.3mm blade). (B type pin configuration). Suitable relay sockets are 140301, 140303, 140304 & 140305 - see p.137.

**140204**

**£7.25**



**Twin make and break.** 30A. 5 terminals (6.3mm blade). (B type pin configuration). Suitable relay sockets are 140301, 140303, 140304 & 140305 - see p.137.

**140205**

**£6.56**



**Twin make and break.** Two 12V make and break relays mounted on one common bracket. (B type pin configurations).

**140212**

**£11.04**



**Change over.** 20/30A. 5 terminals (6.3mm blade). Metal mounting lug can be removed if necessary. (B type pin configuration). Suitable relay sockets are 140301, 140303, 140304 & 140305 - see p.137.

**140206**

**£6.39 / each**

**£57.55 / 10**



**Change over.** 20/30A. 5 terminals (6.3mm blade). Metal mounting lug can be removed if necessary. (B type pin configuration). Has internal diode across the the coil connections (85 & 86) to reduce the voltage spike across these terminals when the coil is de-energised. Suitable relay sockets are 140301, 140303, 140304 & 140305 - see p.137.

**140251**

**£6.67 / each**

**£60.03 / 10**



**Heavy duty make and break.** 70A. 4 terminals (2 x 6.3mm and 2 x 9.5mm blades). (B type pin configuration). Suitable relay socket 140302 only - see p.137.

**140203**

**£10.17**



**Extra heavy duty make and break.** 100A @ 12V. Has 2 x M6 stud connectors (for circuit to be switched) and 2 x 6.3mm male blade connectors (trigger connections). Approx 45mm x 45mm x 45mm, with integral bracket. This unit will not fit into a relay socket.

**140211**

**£18.61**



**Change over latching relay.** Can be remotely controlled by a momentarily on switch. For example, use this as a dip switch with a push button switch to change between main beam and dip and vice versa. 12V, 25A with resistor. (If the power is disconnected the relay will remain in its present state, rather than revert back). Has metal bracket so it can be clipped to a panel. This unit will not fit into a relay socket.

**140209**

**£24.49**

### YOU MAY ALSO BE INTERESTED IN:

- Timer Relays - p.133 & 134
- Lucas Relays - p.135 & 136

## RELAYS - 24V



**Adjustable timer relay.** Adjustable between 0.5 seconds and 6 hours. Effectively a change over relay, so it can be used to either switch on after a certain time period, or switch off. It requires a momentary voltage pulse to trigger. Relay time is changed by turning two small normally hidden (by removable bungs) rotary switches. Supplied with instructions. Will fit a standard relay socket (140301, 140303 or 140305) - see p.137. Capacity 10A. If a higher current needs to be switched, then this relay can be used to trigger a greater capacity switching relay.

**140272**

**£40.32**



**Change over.** 10/20A. 5 terminals (6.3mm blade). Metal mounting lug can be removed if necessary. (B type pin configuration). Suitable relay sockets are 140301, 140303, 140304 & 140305 - see p.137.

**140219**

**£5.66**

contd...

## RELAYS - 24V (contd)



**Heavy duty make and break with resistor.** 70A. 4 terminals (2 x 6.3mm and 2 x 9.5mm blades). (B type pin configuration). These relays have an internal resistor across the coil connections (85 & 86) to reduce the voltage spike across these terminals when the coil is de-energised. Unlike a diode, resistors are less fragile and are not polarity sensitive, although they aren't quite as efficient at reducing voltage spikes. Suitable relay socket 140302 only - see p.137.

**140222**

**£9.44**



**Timer Relay 15 seconds OFF.** 20A capacity. Switches off after 15 seconds. Once the relay is triggered (by applying 12V to terminal 15), the output terminal (87) will become live. After 15 seconds the relay will change state and the voltage at the output terminal drops back to 0 Volts (ie switches off). Will fit relay sockets 140301, 140303, relay box 140304 (without lid) and 140305 - see p.137.

**140275-24**

**£26.43**



**Change over with diode.** 10/20A. 5 terminals (6.3mm blade). Metal mounting lug can be removed if necessary. (B type pin configuration). Has internal diode across the coil connections (85 & 86) to reduce the voltage spike across these terminals when the coil is de-energised. Suitable relay sockets are 140301, 140303, 140304 & 140305 - see p.137.

**140226**

**£6.67**



**Change over latching relay.** Can be remotely controlled by a momentarily on switch. For example, use this as a dip switch with a push button switch to change between main beam and dip and vice versa. 12.5A with resistor. This unit will not fit into a relay socket.

**140221**

**£25.75**



**Extra heavy duty make and break.** 100A @ 24V. Has 2 x M6 stud connectors (for circuit to be switched) and 2 x 6.3mm male blade connectors (trigger connections). Approx 45mm x 45mm x 45mm, with integral bracket. This unit will not fit into a relay socket.

**140294**

**£29.57**



Lucas 33RA SRB601. **Normally open (continuous) relay.** 40A capacity. 4 terminals. 85 & 86 are the coil connections (6.3mm blade). 30, feed in and G, load out are screw connections. When energised terminals 30 and G are connected. (Replaces Lucas 33420).

**140231**

**£19.50**



Lucas 33RA SRB632. **Normally open (Intermittent) relay.** 40A capacity. 4 terminals. 85 & 86 are the coil connections (6.3mm blade). 30, feed in and G, load out are screw connections. When energised terminals 30 and G are connected. (Replaces Lucas relay 33452).

**140234**

**£26.50**



**Make and break.** 20A, 4 terminals (6.3mm blade, B type pin configuration). Suitable relay sockets are 140301, 140303, 140304 & 140305 - see p.137.

**140220**

**£4.16**

## RELAYS - 12V - TIMER



**Interior light delay relay.** 12V. Gives 10 seconds delay to interior lights going off. 4 x 6.3mm blade connections. (Supplied with wiring diagram). Will fit a standard relay socket (140301, 140303 or 140305) - see p.137.

**140207**

**£15.15**



12V timer relay which switches **off after 10 minutes.** Useful for functions such as heated screens, etc. 5 x 6.3mm blade connections. 20A capacity. (Only needs a momentary 12V pulse to trigger relay). Will fit a standard relay socket (140301, 140303 or 140305) - see p.137.

**140270**

**£15.49**

contd...



## RELAYS - TIMER (contd)



12V Timer **2.5 seconds OFF**. Switches off after 2.5 seconds. Once the relay is triggered (by applying 12V to terminal 15), the output terminal (87) will become live. After 2.5 seconds the relay will change state and the voltage at the output terminal drops back to 0 Volts (ie switches off). Will fit relay sockets 140301, 140303, relay box 140304 (without lid) and 140305 - see p.137.

**140276**

**£25.01**



12V Timer **2.5 seconds ON**. Switches on after 2.5 seconds. Once the relay is triggered (by applying 12V to terminal 15), the relay will change state after 2.5 seconds, and terminal 87 will become live. Will fit relay sockets 140301, 140303, relay box 140304 (without lid) and 140305 - see p.137.

**140351**

**£25.01**



12V Timer **15 seconds OFF**. Switches off after 15 seconds. Once the relay is triggered (by applying 12V to terminal 15), the output terminal (87) will become live. After 15 seconds the relay will change state and the voltage at the output terminal drops back to 0 Volts (ie switches off). Will fit relay sockets 140301, 140303, relay box 140304 (without lid) and 140305 - see p.137.

**140275**

**£25.01**



12V Timer **15 seconds ON**. Switches on after 15 seconds. Once the relay is triggered (by applying 12V to terminal 15), the relay will change state after 15 seconds, and terminal 87 will become live. Will fit relay sockets 140301, 140303, relay box 140304 (without lid) and 140305 - see p.137.

**140350**

**£25.01**



**Adjustable timer relay.** Adjustable between 0.5 seconds and 6 hours. Effectively a change over relay, so it can be used to either switch on after a certain time period, or switch off. It requires a momentary voltage pulse to trigger. Supplied with instructions. Will fit a standard relay socket (140301, 140303 or 140305) - see p.139. Capacity 10A. If a higher current needs to be switched, then this relay can be used to trigger a greater capacity switching relay.

**140271**

**£39.43**

## RELAYS - LUCAS



Lucas SRB301 22RA **12V double make and break starter relay**. 9 x lucar terminals. OEM: 33356 33336

**LUCAS SRB301**

**£42.86**



Lucas 33RA SRB600 **12V Normally open (continuous) relay**. 60A capacity. 4 terminals. 85 & 86 are the coil connections (6.3mm blade). 30, feed in and G, load out are screw connections. When energised terminals 30 and G are connected. Black body. (Replaces Lucas 33419).

**140232**

**£19.50**



Lucas 33RA SRB601 **24V Normally open (continuous) relay**. 40A Capacity. 4 terminals. 85 & 86 are the coil connections (6.3mm blade). 30, feed in and G, load out are screw connections. When energised terminals 30 and G are connected. Red body. (Replaces Lucas 33420).

**140231**

**£19.50**



Lucas 33RA SRB631 **12V Normally open (intermittent) relay**. 60A Capacity. 4 terminals. 85 & 86 are the coil connections (6.3mm blade). 30, feed in and G, load out are screw connections. When energised terminals 30 and G are connected. Green body. (Replaces Lucas Relay 33451).

**140233**

**£21.62**



Lucas 33RA SRB632 **24V Normally open (intermittent) relay**. 40A Capacity. 4 terminals. 85 & 86 are the coil connections (6.3mm blade). 30, feed in and G, load out are screw connections. When energised terminals 30 and G are connected. Blue body. (Replaces Lucas relay 33452).

**140234**

**£26.50**



Lucas SRB111 **make and break** relay. 20A switching capacity. Normally open.

**140208**

**£20.87**



## RELAYS - LUCAS (contd)



Lucas SRB630 60A **split charge relay**. Enables connection of second battery and/or fridge. Can be triggered from ignition supply or alternator warning light terminal. (Replaces Lucas 33441).

**140235**  
**£26.03**



Lucas SCB312 13DA **dim/dip relay**. When fitted, it reduces the intensity of the dip beam lights when driving with the light switch in the side light position, ensuring that the vehicle cannot be driven on side lights alone. (Replaces Lucas 33470).

**140291**  
**£24.13**



Lucas SRB500 **change over relay**. 20/30A 12V 5 x lucar terminals. (Equivalent to 140206 - p.130). Supplied without a bracket.

**140240**  
**£7.83**



Lucas SRB411 (33374) **change over relay**. 12V 20A with 5 x lucar terminals. Includes 2 x fixing brackets. (Equivalent to 140206 - p.130).

**LUCAS SRB411**  
**£26.04**



LUCAS SRB400 26RA 12V 2 x 20A 5 x lucar terminals. **Double make and break** (B type pin configuration).

**LUCAS SRB400**  
**£18.49**

## STANDARD RELAY SOCKETS & BOXES



Fixed relay sockets suitable for standard relays. Sockets can be clipped together to form a block. Supplied with all terminals. Spare terminals are also available - see p.48.



Part No.	Blade Terminal Configuration	Each
<b>140301</b>	5 x 6.3mm & 4 x 2.8mm	<b>£2.39</b>
<b>140302</b>	2 x 9.5mm, 3 x 6.3mm & 4 x 2.8mm	<b>£3.72</b>



Flying socket. Can accept relays with up to 5 x 6.3mm blade terminals (except latching relay 140209). Supplied with all terminals.

**140303**  
**£2.11**



Relay socket to take standard relays (having 6.3mm blade terminals) moulded together with 3 blade fuse holders. Can be clipped together to form a block. Supplied with all terminals.

**140305**  
**£3.79**



Spare terminal for relay socket.

**050203**  
**£0.61 / 10**



Spare terminal for fuse socket.

**031401**  
**£1.58 / 10**



Accepts 4 x standard relays. Comes complete with transparent lid, gasket, terminals and terminal locking bar. Terminals are crimped onto wires and then inserted into the base of the relay box. Can be clipped together, to the 16-way fuse box (100110 - p.150) or micro relay box (140307 - see p.138) to form an integrated unit (shown left). Relay box size H64 x W123 x D42mm. Supplied without relays. **Does not accept** the following relays: 140202, 140203 and 140209.

**140304**  
**£22.74**



## RELAYS - MICRO



12V **make and break micro relay**. 25A. 2 x 4.8mm (switching) & 2 x 6.3mm (load) blade terminals. Approximate dimensions 22mm x 25mm (tall) x 13mm. Will fit relay socket 140306 & relay box 140307 - see below.

**140261**

**£5.08**



12V **change over micro relay**. 10/20A. 3 x 4.8mm & 2 x 6.3mm blade terminals. Approximate dimensions 22mm x 25mm (tall) x 13mm. Suitable relay sockets are 140306 and 140307 - see below.

**140260**

**£6.03**



12V **change over micro relay with diode**. 10/20A. 3 x 4.8mm & 2 x 6.3mm blade terminals. Approximate dimensions 22mm x 25mm (tall) x 13mm. Has internal diode across the the coil connections (1 & 2) to reduce the voltage spike across these terminals when the coil is de-energised. Suitable relay sockets are 140306 and 140307 - see below.

**140282**

**£6.04**

## MICRO RELAY SOCKETS & BOXES



Relay socket suitable for micro relays. Sockets can be clipped together to form a block. Supplied with all terminals. Spare terminals are also available - see p.48.

**140306**

**£2.84**



Accepts 7 x micro relays. Comes complete with transparent lid, gasket, terminals and terminal locking bars. Terminals are crimped onto wires and then inserted into the base of the relay box. Can be clipped together, to the 16-way fuse box (100110 - p.150) or standard relay box (140304 - p.137) to form an integrated unit. Box size H64 x W123 x D42mm. Supplied without relays.

**140307**

**£27.54**

## FLASHER UNITS - 6V



Hella Part no 4AZ 003 787-05. Suitable for 1 to 5 x 18/21W 6V bulbs, so can be used as a hazard relay too. **Negative earth only**. Supplied with detachable mounting bracket and separate earth lead. Has a terminal for dashboard warning light. Suitable relay sockets are 140301, 140303 & 140305 - see p.137. **NB**. This will **not** fit relay socket 140304.

**140120**

**£42.78**



2 x 21W capacity (but will happily flash with as little as 10W in total). Supplied with mounting bracket. Connection via 3 x 6.3mm blade terminals. **Suitable for negative earth vehicles only and for use with conventional bulbs, not LEDs**. Suitable relay sockets are 140301, 140303 & 140305 - see p.137. **NB**. This will **not** fit relay socket 140304.

**140108**

**£8.98**

## FLASHER UNITS - 12V



Electronic hazard/flasher unit. 2/4 x 21W + 5W capacity. 3 x 6.3mm blade terminals. Supplied with wiring diagram. **Can be used on both positive and negative earth vehicles**. This relay has a 'blown bulb detection' feature. This means that if one of the indicator bulb fails, then the warning lamp on the dash will stop flashing. This feature also indicates if the wrong rating bulbs have been used. For this unit to operate correctly, 21W indicator bulbs need to be used. This relay is of the most common format used and will replace mechanical Lucas type units. (Case size is 30mm x 30mm x 46mm long).

**140102**

**£10.58**



Electronic hazard/flasher unit. 2/4 x 21W + 5W capacity. 4 x 6.3mm blade terminals. Requires earth. Supplied with wiring diagram. **Negative earth only**.

**140103**

**£14.85**

contd...

## FLASHER UNITS - 12V (contd)



Electronic flasher unit having 3 terminals (one of which an earth connection). 2/4 x 21W capacity. Connections via 6.3mm blade terminals: 31- Earth, 49- Feed in, 49a- Flashing signal out (to indicator switch). **For use on negative earth vehicles only.** This format of flasher relay was commonly fitted to Alfa Romeo, Audi, BMW, Ford, Opel, Saab, Volvo & VW. The more common 3 terminal flasher relay is our part 140102 - p.139.

**140112**

**£10.38**



Electronic flasher unit that can operate LED indicator bulbs or a mixture of LED bulbs and conventional bulbs. Useful when used with LED replacement bulbs. 3 x 6.3mm blade terminals. **Negative earth only.** Capacity up to 30W. (When using these relays to replace an existing unit, ensure that the terminal marked 'P' goes to a warning lamp and not to earth. If connected directly to earth, the relay will be damaged).

**140107**

**£14.63**



Electronic LED flasher unit having 3 terminals (one of which an earth connection). Connections via 6.3mm blade terminals: E- Earth, B- Feed in, L- Flashing signal out (to indicator switch). **For use on negative earth vehicles only.** Will operate LED indicator lights and conventional bulbs or a mix of both. Max: 30W. This relay is the same as 140112 except has a lower maximum wattage.

**140118**

**£14.63**



Lucas SFB105 flasher unit. 42W capacity. Aluminium can with integral mounting bracket. 3 x 6.3mm blade terminals: B (or X)- Power in, P- Feed to warning lamp, L- Flasher signal out. **Can be used for both positive and negative earth vehicles.** Replaces Lucas FL5.

**140110**

**£10.85**

**140110-REP**

**£7.88**

Replica item 140110-REP also available.

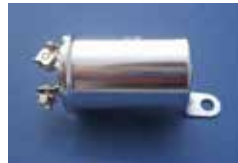

Lucas SFB100 flasher unit. 42W capacity. Aluminium can with integral mounting bracket. 3 x screw terminals: B (or X)- Power in, P- Feed to warning lamp, L- Flasher signal out. **Can be used for both positive and negative earth vehicles.**

**140111**

**£11.45**

**140111-REP**

**£7.88**

Replica item 140111-REP also available.



Lucas SFB114 (35048) (8FL) 47W 2 pin flasher unit. 2 x 21W + 5W (warning light). Use the SFB130 (below) if your vehicle has hazard lights.

**LUCAS SFB114**

**£8.34**



Lucas SFB130 (9FL) flasher unit. 4 x 21W + 5W. Maximum load 94W.

**LUCAS SFB130**

**£8.34**



Electronic flasher unit having 3 terminals (one of which is an earth connection). 2/4 x 21W capacity. Connections via 6.3mm blade terminals: 31- Earth, 49- Feed in, 49a- Flashing signal out (to indicator switch). **For use on negative earth vehicles only.**

**LUCAS SFB161**

**£14.58**



Lucas DB10 flasher unit. To enable brake lights to also be used as rear indicators. 8 x screw terminals. Supplied with wiring diagram. **Suitable for negative and positive earth systems.** This unit needs to be wired in conjunction with a suitable flasher unit- for example 140102 - p.139.

**140105**

**£85.30**

### YOU MAY ALSO BE INTERESTED IN:

- Trailer Relays - p.232
- Indicator Kits - p.115 & 116

## FLASHER UNITS - 24V



Electronic flasher unit having 3 terminals (one of which an earth connection). 2/4 x 21W capacity. Connections via 6.3mm blade terminals: 31- Earth, 49- Feed in, 49a- Flashing signal out (to indicator switch). **For use on negative earth vehicles only.**

**140115**

**£15.09**



Electronic hazard/flasher unit. 2/4 x 21W + 5W capacity. 3 x 6.3mm blade terminals. Supplied with wiring diagram. **Can be used on both positive and negative earth vehicles.** This relay has a 'blown bulb detection' feature. This means that if one of the indicator bulbs fail, then the warning lamp on the dash will stop flashing. This feature also indicates if the wrong rating bulbs have been used. For this unit to operate correctly, 21W indicator bulbs need to be used. This relay is of the most common format used and will replace mechanical Lucas type units.

**140119**

**£10.69**

## CONTINENTAL FUSES



Otherwise known as ceramic or torpedo fuses. Historically used on many older European cars. **Rating values on these fuses are the continuous ratings. They will blow at double this figure.**

Part No.	Rating (A)	Colour	10	50
100401	5	Yellow	£1.85	£5.52
100402	8	White	£1.85	£5.52
100403	16	Red	£1.85	£5.52
100404	25	Blue	£1.85	£5.52

## FUSE BOXES - CONTINENTAL TYPE



Available in 2, 4, 6, 8 and 12 way. Moulded phenol base and cover (held on with thumb screw). Available with **clear** or **black** cover. Screw terminals. Supplied with 8A continental fuses.

Part No.	Colour	No. of Fuses	Size (mm)	Each
100101-B	Black	2	30 x 45 x 25	£6.69
100101-C	Clear	2	30 x 45 x 25	£6.69
100102-B	Black	4	60 x 45 x 25	£8.97
100102-C	Clear	4	60 x 45 x 25	£8.97
100103-B	Black	6	90 x 45 x 25	£13.04
100103-C	Clear	6	90 x 45 x 25	£13.04
100104-B	Black	8	120 x 45 x 25	£18.28
100104-C	Clear	8	120 x 45 x 25	£18.28
100112-B	Black	12	180 x 45 x 25	£24.39
100112-C	Clear	12	180 x 45 x 25	£24.39

## SINGLE FUSE HOLDER - CONTINENTAL TYPE



Moulded in black phenol. Bayonet fixing with screw terminals. Supplied with 8A fuse. Suitable for up to 4mm<sup>2</sup> cable.

**100201**

**£1.54**

## GLASS FUSES



30mm long x 6.3mm dia. **Rating values on these fuses are the continuous ratings. They will blow at double this figure.**

Part No.	Rating (A)	10	50
100501	2	£1.71	£5.94
100502	5	£1.71	£5.94
100503	10	£1.71	£5.94
100504	15	£1.71	£5.94
100505	20	£1.71	£5.94
100506	25	£1.71	£5.94
100507	30	£1.71	£5.94
100508	50	£1.71	£5.94

## FUSE BOXES - GLASS TYPE (LUCAS)



Lucas 4FJ (54038068). Surface mounted 2-way fuse box with detachable cover. Accepts glass fuses. Connections via 6.3mm blade terminals. Has space for two spare fuses.

**100118**

**£12.51**



Lucas 6FJ (37409). Panel mounted 4-way fuse box with detachable cover. Accepts glass fuses. Connections via 6.3mm blade terminals on underside. Suitable for mounting through a bulkhead. Has space for two spare fuses.

**100119**

**£31.11**



Lucas SF6 (37132). Surface mounted 2-way fuse box. Accepts two glass fuses. Connections via screw terminals. No cover.

**100117**

**£28.93**



Lucas 6FJ (37564). Panel mounted 4-way fuse box with detachable cover. Accepts glass fuses. Connections via 6.3mm blade terminals on underside. Suitable for mounting through a bulkhead. Has space for two spare fuses.

**100125**

**£17.87**



Lucas 7FJ (37420). Surface mounted 4-way fuse box with detachable cover. Accepts glass fuses. Connections via side mounted 6.3mm blade terminals. Has space for two spare fuses.

**100120**

**£18.25**



Lucas SF4. Surface mounted 4-way fuse box. Accepts four glass fuses. Connections via screw terminals. Phenol lid held on with knurled screw. Has space for 2 spare fuses. Genuine Lucas item.

**100116**

**£71.66**



Spare lid for Lucas SF4 fuse box.

**100116-L**

**£19.81**



Spare screw for Lucas SF4 fuse box.

**100116-LS**

**£5.94**



**Replica** Lucas SF4. This is a very good replica of the Lucas SF4 fuse box (100116). Surface mounted 4-way fuse box. Accepts four glass fuses. Connections via screw terminals. Phenol lid held on with knurled screw. Has space for 2 spare fuses. Centre hole distance 44mm.

**100126**

**£27.29**



## SINGLE FUSE HOLDERS - GLASS TYPE



Chassis mounted phenolic fuse holder, designed to accommodate 30mm glass fuses. Single hole fixing with anti-rotation spigot. Terminated by 6.3mm blade terminals. 30A current rating. Tin nickel plated brass contact. Black phenolic body. 150°C operating temperature. 12mm x 43mm base

**100223**

**£2.84**



For 30mm glass fuses, supplied with flying leads. Moulded in white nylon. Bayonet fixing. No fuse supplied.

Part No.	Current Capacity (A)	Each
<b>100203</b>	17	<b>£1.16</b>
<b>100214</b>	8	<b>£1.12</b>



For 30mm glass fuses. Moulded in black phenol. Screw cable connections. Supplied with 35A fuse. Suitable for up to 4mm<sup>2</sup> cable.

**100204**

**£3.44**



Panel mounted fuse holder for 30mm glass fuses up to 35A. Requires 13mm diameter hole. Has 6.3mm blade connections. Screw on cap retains fuse. (Please note, fuse not supplied).

**100205**

**£6.41**



Splash proof in-line fuse holder for 30mm fuses up to 10A. Has PVC grommets and O ring. Nickel plated brass screw connections. No fuse supplied. Suitable for up to 1mm<sup>2</sup> cable.

**100206**

**£5.32**

## FUSE KIT - OLDER VEHICLE



Contains 180 assorted continental and glass fuses packed into a robust case with dividers.

**160111**

**£24.30**

## STRIP FUSES



41mm x 11mm. (Suitable for fuse holders with studs on 30mm hole centres). **Rating values on these fuses are the continuous ratings. They will blow at double this figure.**

Part No.	Rating (A)	Each	10
<b>100601</b>	30	<b>£0.46</b>	<b>£3.55</b>
<b>100602</b>	40	<b>£0.46</b>	<b>£3.55</b>
<b>100603</b>	50	<b>£0.46</b>	<b>£3.55</b>
<b>100604</b>	60	<b>£0.46</b>	<b>£3.55</b>
<b>100605</b>	80	<b>£0.46</b>	<b>£3.55</b>
<b>100606</b>	100	<b>£0.46</b>	<b>£3.55</b>

## SINGLE FUSE HOLDER - STRIP TYPE



Strip fuse holder. Cable connections are made using the protruding M5 studs. Moulded in black plastic. Supplied without fuse. Maximum cable diameter approx 7mm.

**100213**

**£3.22**

## BLADE FUSES - STANDARD

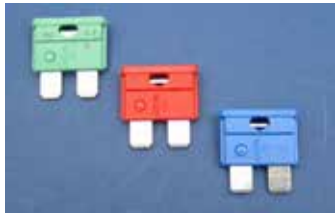

*Rating values on these fuses are the continuous ratings. They will blow at double this figure.*

Part No.	Rating (A)	Colour	Each	50
100301	1	Black	£0.24	£5.82
100302	2	Grey	£0.24	£5.82
100303	3	Violet	£0.24	£5.82
100304	4	Pink	£0.24	£5.82
100305	5	Tan	£0.24	£5.82
100306	7.5	Brown	£0.24	£5.82
100307	10	Red	£0.24	£5.82
100308	15	Blue	£0.24	£5.82
100309	20	Yellow	£0.24	£5.82
100310	25	Natural	£0.24	£5.82
100311	30	Green	£0.24	£5.82
100312	40	Orange	£0.24	£5.82



Blade fuse extractor. Makes extracting blade fuses easier. Also for use with standard illuminating fuses (next page).

**100701**

**£0.55**



Fig. 164. Various types of Fuse Boxes.

## BLADE FUSES - STANDARD (ILLUMINATING)



Standard blade fuses, but with indicator lamp built in. If the fuse blows, the (LED) indicator lamp lights, making it clear which fuse has blown. Designed to replace standard blade fuses. *Rating values on fuses are the continuous ratings. They will blow at double this figure.*

Part No.	Rating (A)	Colour	Each	10
101201	2	Grey	£1.18	£10.15
101202	3	Violet	£1.18	£10.15
101203	4	Pink	£1.18	£10.15
101204	5	Tan	£1.18	£10.15
101205	7.5	Brown	£1.18	£10.15
101206	10	Red	£1.18	£10.15
101207	15	Blue	£1.18	£10.15
101208	20	Yellow	£1.18	£10.15
101209	25	Natural	£1.18	£10.15
101210	30	Green	£1.18	£10.15
101211	40	Orange	£1.18	£10.15

## GENERAL FUSE KIT



Contains 200 assorted continental, glass and blade fuses packed into a robust case with dividers.

**160103**

**£36.38**

## BLADE FUSE KIT



Contains 100 assorted standard sized blade fuses packed into a robust plastic case with dividers.

**160112**

**£21.46**

## FUSE BOXES - STANDARD BLADE TYPE



Surface mounted fuse box for blade type fuses - p.148. Available in 4 or 6 way. Black moulded base and transparent cover. Connection via 6.3 mm blade terminals on underside. Supplied without fuses.

Part No.	Type	Dimensions (mm)	Each
<b>100105</b>	4-way	H58 x W52 x D26	<b>£3.61</b>
<b>100106</b>	6-way	H58 x W72 x D26	<b>£4.26</b>



Surface mounted fuse box for blade type fuses - p.148. Available in 4, 6 or 8 way. Black moulded base, transparent cover and gasket. Connection via 6.3mm blade terminals on each side of fuse box. (Supplied without fuses).

Part No.	Type	Dimensions (mm)	Each
<b>100107</b>	4-Way	H36 x W79 x D26	<b>£4.56</b>
<b>100108</b>	6-Way	H36 x W100 x D26	<b>£6.67</b>
<b>100109</b>	8-Way	H36 x W115 x D26	<b>£8.73</b>



Surface mounted 16 way blade type fuse box. Takes standard blade fuses - p.150. Black moulded base and transparent cover. Comes with terminals & terminal locking bar. Terminals are crimped onto wires and then inserted into base of fusebox. Supplied without fuses. These fuse boxes can be clipped together to form 32 or 48 way units, and to relay box 140304 (p.137) or micro relay box 140307 (p.138). H64 x W123 x D42mm.

<b>100110</b>
<b>£25.19</b>



Panel mounted 8 way blade type fuse box. Black with transparent cover and gasket. Designed to fit through a panel aperture. 6.3mm blade connections on underside of box. Supplied without standard blade fuses. (H42 x W88 x D32mm). The distance between hole centres is 103mm.

<b>100111</b>
<b>£8.07</b>



6-way blade fuse box and distribution board. This board has terminals for both the negative (earth) and positive sides of the circuits. Approximate dimensions including the lid are 125 x 95 x 60mm (tall). The unit and lid are both polycarbonate. Fuses are **not** included within the fuse box. If required, there is also sufficient room within the fuse box to fit the blade type circuit breakers (p.162).

- \* Maximum Amperage per circuit - 30A
- \* Maximum Amperage per block - 100A
- \* Maximum voltage - 32V DC.

<b>100133</b>
<b>£32.77</b>



12-way blade fuse box and distribution board. This board has terminals for both the negative (earth) and positive sides of the circuits. Approximate dimensions including the lid are 165 x 95 x 60mm (tall). The unit and lid are both polycarbonate. Fuses are **not** included within the fuse box. If required, there is also sufficient room within the fuse box to fit the blade type circuit breakers (p.162).

- \* Maximum Amperage per circuit - 30A
- \* Maximum Amperage per block - 100A
- \* Maximum voltage - 32V DC.

<b>100134</b>
<b>£37.13</b>



A range of fuse boxes with one common feed (M5 stud) that accept standard blade fuses. The output connections are 6.3mm blade terminals. Supplied with plastic lids. Please note that the blade fuses shown in the photos are **not** included with the fuse box. Fuse box maximum loads 100A. 5mm fixing holes with 28mm centre distance.

Part No.	Type	Dimensions (mm)	Each
<b>100136</b>	4-way	47 x 85 x 36	<b>£10.71</b>
<b>100137</b>	6-way	64 x 85 x 36	<b>£13.53</b>
<b>100138</b>	8-way	95 x 85 x 36	<b>£16.18</b>

contd...

## FUSE BOXES - STANDARD BLADE TYPE (contd)



A range of 4, 6 and 10 way blade fuse boxes that have both LED blown fuse indicators and a busbar input. If a fuse blows then an LED will illuminate indicating which fuse has blown. Each fuse box has a removable plastic lid. Power in is via a single M5 stud, which connects to one side of all fuses. Each fuse has its own feed out connection which is a 6.3mm male blade. These fuse boxes are very useful in applications that are not space critical and also that are potentially in the dark, as the blown fuse can be easily found.

Part No.	Type	Dimensions (mm)	Each
<b>100130</b>	4-way	85 x 47	<b>£9.74</b>
<b>100131</b>	6-way	85 x 63	<b>£11.73</b>
<b>100132</b>	10-way	85 x 95	<b>£16.96</b>



10-way splash proof fuse box & lid with LED indicators to indicate fuse failure. Has the following features: Takes standard blade fuses (not supplied) - blade type circuit breakers will not fit. Lid also has integral gasket. Is panel mounted and supplied with gasket. 25A capacity per fuse / 150A total for fuse box. Approx 86mm x 121mm x 30mm (above panel). 4 x 5mm mounting holes on 75 & 110mm centres. 6.3mm blade connections.

**100140**  
**£26.83**



Battery mounted fuse box. Clamps directly to the positive battery terminal. It is compact and easy to install and offers the following: 1 x 8mm stud terminal (unfused, to connect original battery lead to), 4 x 5mm stud terminal (unfused), 2 x 5mm stud terminal (fused via midi fuses), 8 x maxi fused out puts (crimped connections). The unit has 2 lids with hinges and is 110mm wide x 140mm long. When mounted on a battery, it only adds 25mm to the height of the battery. It also comes with some additional fixings to enable it to be more rigidly fixed to the battery if necessary.

**100135**  
**£44.92**



## SINGLE FUSE HOLDERS - BLADE TYPE



Blade fuse holder. Can be clipped together to form a fuse block. 6.3mm blade connectors in base. Clear plastic cover (100209) also available. Requires mounting plate (100210) if required to fix to a surface. Takes standard blade fuses.

**100208**  
**£1.09**



Clear plastic cover for blade fuse holder (above).

**100209**  
**£0.29**



Mounting plate for blade fuse holder (above).

**100210**  
**£0.36**



Splashproof blade fuse holder that can be clipped together to form a multiple fuse box. The fuse holder is supplied complete with cover, silicon gasket, terminal locking bar, 2 terminals and 2 seals. Two versions available with terminals to suit different size cables. Requires mounting plate (100222) if required to fix to a surface.

Part No.	To fit Cable Size (mm <sup>2</sup> )	Each
<b>100220</b>	0.5- 1.5	<b>£2.51</b>
<b>100221</b>	2.0- 3.0	<b>£2.51</b>



Mounting plate for splashproof fuse holder (above).

**100222**  
**£0.69**



Blade fuse holder. Can be clipped together to form a fuse block. 6.3mm blade connections on each side. Requires mounting plate (100210 - see above) to fix it to a surface.

**100207**  
**£1.16**

contd...



## SINGLE FUSE HOLDERS - BLADE TYPE (contd)



Blade fuse holder on flying leads. (150mm long) Current rating 30A.

**100212**  
**£3.11**



Panel mounted blade fuse holder. Requires mounting hole 22 x 11mm. 6.3mm blade terminals. 30A max.

**100211**  
**£1.58**



'Add a Circuit' blade fuse holder. This item can be used to gain another fused circuit when used to replace an existing fuse within a fuse box.

**100215**  
**£8.04**



Blade fuse holder on flying leads with blown fuse LED. Takes standard blade fuses. The built-in LED glows when the fuse has blown, also fitted with a lid to prevent water ingress. Total length - 330mm.

Part No.	Current Capacity (A)	Each
<b>100230</b>	20	<b>£4.40</b>
<b>100231</b>	30	<b>£4.70</b>



## BLADE FUSES - MINI



Slightly smaller than the standard blade fuse. **Rating values on fuses are the continuous ratings. They will blow at double this figure.**

Part No.	Rating (A)	Colour	Each	50
<b>101101</b>	2	Grey	<b>£0.27</b>	<b>£10.28</b>
<b>101102</b>	3	Violet	<b>£0.27</b>	<b>£10.28</b>
<b>101103</b>	4	Pink	<b>£0.27</b>	<b>£10.28</b>
<b>101104</b>	5	Tan	<b>£0.27</b>	<b>£10.28</b>
<b>101105</b>	7.5	Brown	<b>£0.27</b>	<b>£10.28</b>
<b>101106</b>	10	Red	<b>£0.27</b>	<b>£10.28</b>
<b>101107</b>	15	Blue	<b>£0.27</b>	<b>£10.28</b>
<b>101108</b>	20	Yellow	<b>£0.27</b>	<b>£10.28</b>
<b>101109</b>	25	Natural	<b>£0.27</b>	<b>£10.28</b>
<b>101110</b>	30	Green	<b>£0.27</b>	<b>£10.28</b>

## SINGLE FUSE HOLDER - MINI BLADE TYPE



Splashproof mini blade fuse holder on flying leads. Fitted with a lid to prevent ingress of water. Available in both 20A & 30A current capacity. Total length - 330mm.

Part No.	Current Capacity (A)	Each
<b>100240</b>	20	<b>£2.51</b>
<b>100241</b>	30	<b>£2.84</b>



'Add a Circuit' blade fuse holder. This item can be used to gain another fused circuit when used to replace an existing fuse within a fuse box.

**100216**  
**£7.84**



## BLADE FUSES - MAXI



These fuses are larger than the standard blade fuses and are generally for higher current applications. Approximate dimensions H34 x W29.2 x D9 mm. **Rating values on fuses are the continuous ratings. They will blow at double this figure.**

Part No.	Rating (A)	Colour	Each
101401	20	Yellow	£0.89
101402	30	Green	£0.89
101403	40	Orange	£0.89
101404	50	Red	£0.89
101405	60	Blue	£0.89
101406	70	Brown	£0.89
101407	80	Natural	£0.89
101408	100	Violet	£0.89

## SINGLE FUSE HOLDER - MAXI BLADE TYPE



Maxi blade fuse holder. Single fuse holder with protective cover to take MAXI blade fuses. Connection via 8mm<sup>2</sup> cables which are approx 130mm long.

**100219**

**£6.15**

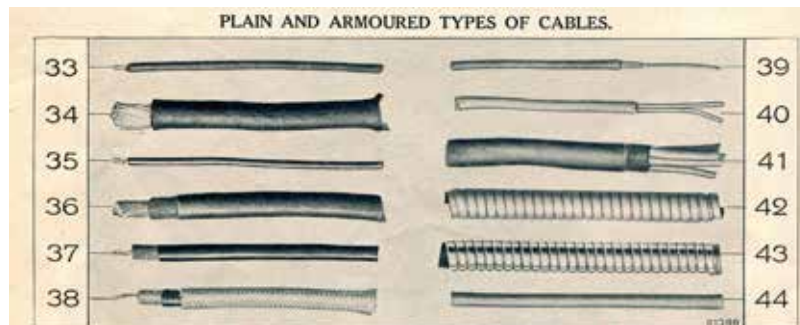

## MIDI FUSES



Midi fuses. (40mm long, 30mm between fixing centres). For fuse holder see below. **Rating values on fuses are the continuous ratings. They will blow at double this figure.**

Part No.	Rating (A)	Colour	Each	5
101501	30	Orange	£2.38	£10.69
101502	40	Green	£2.38	£10.69
101503	50	Red	£2.38	£10.69
101504	60	Yellow	£2.38	£10.69
101505	70	Brown	£2.38	£10.69
101506	80	White	£2.38	£10.69
101507	100	Blue	£2.38	£10.69
101508	125	Pink	£2.38	£10.69
101509	150	Black	£2.38	£10.69

## SINGLE FUSE HOLDER - MIDI TYPE



Midi fuse holder. Cable connections are made using the protruding M5 studs. Moulded in black plastic. Supplied without fuse. Maximum cable diameter approx 7mm.

**100213**

**£3.22**

## MEGA FUSES



Mega fuses. (68mm long, 50mm between fixing centres). For fuse holder see below. **Rating values on fuses are the continuous ratings. They will blow at double this figure.**

Part No.	Rating (A)	Colour	Each
101601	100	Yellow	£4.17
101602	125	Green	£4.17
101603	150	Orange	£4.17
101604	175	White	£4.17
101605	200	Blue	£4.17
101606	225	Brown	£4.17
101607	250	Pink	£4.17
101608	300	Grey	£4.17
101609	350	Green	£4.17
101610	400	Purple	£4.17
101611	450	Orange	£4.17
101612	500	Brown	£4.17

## SINGLE FUSE HOLDER - MEGA TYPE



Fuse holder to take mega fuses. Cable connections are made using the protruding M8 studs, suitable for ring terminals. Moulded in black plastic. Supplied with lid, but without fuse. Can be clipped together to form a bank of fuse boxes. Maximum cable diameter approx 14mm.

**100218**  
**£6.75**

## PAL 295 FUSES

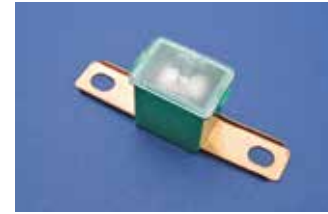

PAL 295 male fuses (48mm between fixing centres). **Rating values on fuses are the continuous ratings. They will blow at double this figure.**

Part No.	Rating (A)	Colour	Each	5
100703	30	Pink	£3.63	£16.36
100704	40	Green	£3.63	£16.36
100705	50	Red	£3.63	£16.36
100706	60	Yellow	£3.63	£16.36
100707	70	Brown	£3.63	£16.36
100708	80	Black	£3.63	£16.36
100709	100	Blue	£3.63	£16.36

## PAL FUSES - J TYPE



J Type PAL Fuses. (Main part of body approximately 10mm x 12mm square). **Rating values on fuses are the continuous ratings. They will blow at double this figure.**

Part No.	Rating (A)	Colour	Each	5
100710	20	Light Blue	£2.96	£13.34
100711	30	Pink	£2.96	£13.34
100712	40	Green	£2.96	£13.34
100713	50	Red	£2.96	£13.34
100714	60	Yellow	£2.96	£13.34
100715	70	Brown	£2.96	£13.34
100716	80	Black	£2.96	£13.34

## PAL FUSES - MALE



PAL fuses (male). **Rating values on fuses are the continuous ratings. They will blow at double this figure.**

Part No.	Rating (A)	Colour	Each	5
100717	30	Pink	£5.07	£22.83
100718	40	Green	£5.07	£22.83
100719	50	Red	£5.07	£22.83
100720	60	Yellow	£5.07	£22.83
100721	80	Black	£5.07	£22.83
100722	100	Blue	£5.07	£22.83

## PAL FUSES - FEMALE



PAL fuses (female). Dimensions: 30 x 22 x 15mm. **Rating values on fuses are the continuous ratings. They will blow at double this figure.**

Part No.	Rating (A)	Colour	Each	5
100730	20	Light Blue	£3.27	£14.73
100731	30	Pink	£3.27	£14.73
100732	40	Green	£3.27	£14.73
100733	50	Red	£3.27	£14.73
100734	60	Yellow	£3.27	£14.73
100735	80	Black	£3.27	£14.73
100736	100	Blue	£3.27	£14.73

## CIRCUIT BREAKERS - PANEL MOUNTED - ETA



A range of high quality small circuit breakers, manufactured by ETA, ranging from 5 to 25A. Suitable for 12-28V systems. Panel mounted (10mm hole required). Button pops out when overloaded. Manually reset by pressing the button. Connection via 6.3mm blade terminals. Body size 46 x 29 x 14mm (excluding button and terminals).

Part No.	Rating (A)	Each
100951	5	£21.50
100952	7	£21.50
100953	10	£21.50
100954	15	£21.50
100955	20	£21.50
100956	25	£21.50



A range of panel mounted circuit breakers (supplied with rubber sealing gaskets) incorporating a push button that can be used to break the circuit and a reset lever to manually remake the circuit. (This reset lever automatically flips downwards to indicate that the unit has tripped). These breakers are sealed and are therefore suitable for use in engine compartments and bilge areas in boats as well as being suitable to protect auxillary circuits in trucks, buses and marine applications. Max voltage 48V DC. Made in USA.

2 x 6.5mm diameter mounting holes. Compliances: SAE J1171 (ignition protected), SAE J1625. Ingress Protection: IP67. Voltage: 48V DC. Interrupt Rating: 3000A @ 30V DC. Operating Temp: -32°C to 82°C. Storage Temp: -34°C to 149°C. Material: Black UL-rated 94V0 thermoset plastic. Rear mounted 6mm stainless steel studs. 60mm x 85mm x 44mm deep (including the push button).

Part No.	Rating (A)	Each
101801	50	£29.72
101802	80	£29.72
101803	100	£29.72

## CIRCUIT BREAKERS - BLADE TYPE



Circuit breakers for 12/24V DC systems. Thermal bi-metallic with manual reset and trip. Replace standard blade fuses in many fuse holders and boxes.

Part No.	Rating (A)	Colour	Each
100807	5	Tan	£8.46
100808	7.5	Brown	£8.46
100803	10	Red	£8.46
100804	15	Blue	£8.46
100805	20	Yellow	£8.46
100806	25	Pearl	£8.46

## CIRCUIT BREAKERS - SURFACE MOUNTED



A range of surface mounted circuit breakers incorporating a push button that can be used to break the circuit and a reset lever to manually remake the circuit. (This reset lever automatically flips downwards to indicate that the unit has tripped). These breakers are sealed and are therefore suitable for use in engine compartments and bilge areas in boats as well as being suitable to protect auxillary circuits in trucks, buses and marine applications. Max voltage 48V DC. Made in USA. 2 x 6.5mm diameter mounting holes.

Compliances: SAE J1171 (ignition protected), SAE J1625. Ingress Protection: IP67. Voltage: 48V DC. Interrupt Rating: 3000A @ 30V DC. Operating Temp: -32°C to 82°C. Storage Temp: -34°C to 149°C. Material: Black UL-rated 94V0 thermoset plastic. Stainless steel studs (6mm on 50-150A versions, 8mm on 200A version). 48.5mm x 74mm x 44mm tall (including the push button).

Part No.	Rating (A)	Each
101701	50	£28.41
101702	60	£28.41
101703	80	£28.41
101704	100	£28.41
101705	150	£28.41
101706	200	£28.41

## STANDARD BULBS - GENERAL INFORMATION

Older style bulbs have a metal cap and are available with cap diameters of 7, 9, 15, 20, 21 and 22mm. 7 & 9mm bulbs are generally used in warning lamps, 15mm in side, indicator and brake lights and 15, 20, 21 and 22mm bulbs in headlamps.

**Bulb names show what type of bulb they will be:**

- BA** = Bayonet fitting with parallel pins
- BAY** = Bayonet fitting with offset pins (bulbs can only be inserted one way)
- ES** = Edison screw fitting
- 15** = 15mm diameter metal cap (20 = 20mm, 9 = 9mm, etc)
- s** = Single contact
- d** = Double contact

For example: a **BA15s** bulb will have a bayonet fitting with parallel pins, a cap of 15mm diameter and is single contact.

## LED BULBS - GENERAL INFORMATION

These **12V** LED bulbs fit into standard bayonet fitting bulb holders and are a replacement for normal bulbs. They have the advantage of being extremely long lasting and require very little current, typically 30mA.

For use on **NEGATIVE EARTH** vehicles only.

For best results, use the same colour LED bulbs behind the same colour lenses.

## LES - STANDARD BULB



LES (Screw-In). Often used as indicator bulbs within switches. Approx 5.3mm diameter x 16.5mm long.

Part No.	Volts	Watts	Fila-ment	Type	Each	10
130108	12	1.5	Single	280	£0.69	£6.07

## MES - STANDARD BULBS



MES (Screw-In). Single contact.

Part No.	Volts	Watts	Fila-ment	Type	Each	10
130104	6	2	Single	990	£0.69	£6.07
130102	12	2.2	Single	987	£0.69	£6.07
130105	12	6	Single	1024	£0.69	£6.07

## MES - LED BULB



1 LED. 12V, warm white. Similar intensity to standard MES bulbs.

Part No.	Colour	Type	Each	10
130107	Warm White	987	£2.91	£26.17

## MES BULB HOLDERS



Flange mounted MES bulb holder. Flange has mounting holes and screw connections. Made from black plastic.

132025

£1.86



Bulb holder, with insulated claws to fit 5/8" dia. panel hole. Supplied with rivet to be crimped or soldered to wire. Suitable for charge warning lamps, etc. Spare rivets available - see below.

132009

£3.65



Bulb holder, with claws to fit 5/8" (15.9mm) dia. panel hole. Supplied with rivet to be crimped or soldered to wire. Bulb is earthed through casing. Spare rivets available - see below.

132008

£3.15



Spare rivet for bulbs holders 132008 & 132009 (above).

132017

£0.25

## BA7s - STANDARD BULBS



BA7s. Miniature bayonet bulbs. Single contact. Metal cap is 7mm in diameter. LED version also available - see below.

Part No.	Volts	Watts	Fila-ment	Type	Each	10
130201	6	1.2	Single	282	£0.82	£6.90
130202	12	2	Single	281	£0.79	£6.57
130203	24	3	Single	283	£0.82	£6.90

## BA7s - LED BULB



1 LED. Overall bulb length 20mm, diameter of LED end 7mm.

Part No.	Colour	Intensity Equiv. (W)	Each	10
132412	White	2	£3.30	£29.72

## BA7s BULB HOLDER



Single contact, single screw connection. Exterior diameter 9.7mm.

132006

£2.00

## BA9s - STANDARD BULBS



Minute bayonet bulbs. Metal base is 9mm in diameter. Single contact, parallel pins.



Part No.	Volts	Watts	Fila-ment	Type	Each	10
130306	6	2	Single	287	£0.68	£5.88
130301	6	3	Single	641	£0.68	£5.88
130302	12	2	Single	288	£0.68	£5.88
130303	12	4	Single	233	£0.68	£5.88
130308	24	2.8	Single	865	£0.68	£5.88



## BA9s - HALOGEN BULBS



Minute bayonet bulbs. Metal base is 9mm in diameter. Single contact, parallel pins.

\* 130307 is amber coloured (see pic).



Part No.	Volts	Watts	Fila-ment	Type	Each	10
130305	12	10	Single	433	£2.84	£25.48
130304	12	20	Single	433	£5.44	£48.92
130307*	12	23	Single	-	£1.89	£16.98

## BA9s - LED BULBS



Similar in intensity to 2W bulbs. 1 LED bulbs: 24mm long, 11mm diameter at LED end. 4 LED bulb: 18mm long, 11mm diameter at LED end.



Part No.	Colour	No. of LEDs	Each	10
132420	Yellow	1	£3.47	£31.21
132422	Soft Yellow	1	£2.89	£26.04
132421	White	4	£3.47	£31.21

## BA9s - BULB HOLDERS



Single contact, single screw connection. Exterior diameter 12.0mm.

**132005**  
**£2.95**



Insulated BA9s bulb holder. Made from plastic. 11.9mm OD. 2 x 6.3mm blade connections.

**132019**  
**£1.66**



Bulb holder with solder connections suitable for BA9s bulbs. 10mm diameter.

**132023**  
**£1.22**

## BA15s - STANDARD BULBS

15mm diameter metal cap, single contact, parallel pins.



Small Globe.

Part No.	Volts	Watts	Fila-ment	Type	Each	10
130401	6	5	Single	205	£0.69	£6.07
130402	6	10	Single	244	£0.69	£6.07
130403	12	5	Single	207	£0.66	£5.73
130404	12	10	Single	245	£0.78	£7.02
130405	12	23	Single	1073	£0.89	£7.57



Medium Globe.

\* 130503 is amber coloured (see pic).



Part No.	Volts	Watts	Fila-ment	Type	Each	10
130501	6	21	Single	317	£0.74	£6.38
130502	12	21	Single	382	£0.69	£6.07
130503*	12	21	Single	343	£1.18	£10.12
130504	24	21	Single	241	£0.74	£6.38



Large Globe.

Part No.	Volts	Watts	Fila-ment	Type	Each	10
130601	12	36	Single	002	£2.64	£22.42
130602	12	45	Single	234	£3.79	£32.00
130604	24	45	Single	623	£3.33	£29.95

## BA15s - HALOGEN BULB



15mm diameter metal cap, single contact, parallel pins. Overall length: 44mm.

Part No.	Volts	Watts	Fila-ment	Type	Each	10
130603	12	50	Single	1050	£5.75	£48.89

## BA15s - LED BULBS

15mm diameter metal cap, single contact, parallel pins.



**9 LEDs.** Similar in intensity to 5W bulbs. Overall bulb length 32mm, diameter of LED end 18mm. Available in **amber, red and white.**

Part No.	Intensity Equiv. (W)	No. of LEDs	Colour	Each
<b>132405</b>	5	9	Amber	<b>£6.34</b>
<b>132407</b>	5	9	White	<b>£10.83</b>



**15 LEDs.** These small 12V LED replacement bulbs can fit vehicle tail lights, brake lights, reverse lights, indicators or side marker lights. These BA15s single contact bulbs have 15 LEDs (3mm & 5mm) - 9 positioned on the top of the bulb and 6 radially mounted on the housing. This gives the bulb a 210° beam angle which also illuminates the inside of the light fitting, increasing their effectiveness. They are also small in size, being only very slightly larger than a small globe BA15s bulb (see pic). Operates from 9V to 14.8V. Designed operational life of 10,000 hours. Available in **red, amber or white.** Overall length 35.7mm, max diameter 18.6mm. Low current draw (Red: 67mA, Amber: 60mA, White: 42mA).



Part No.	Intensity Equiv. (W)	No. of LEDs	Colour	Each
<b>132415</b>	10	15	Red	<b>£9.92</b>
<b>132417</b>	10	15	Amber	<b>£9.92</b>
<b>132416</b>	10	15	White	<b>£9.92</b>



**19 LEDs.** Similar in intensity to 21W bulbs. Fit standard 15mm bulb holders. 46mm long, 25mm diameter at LED end. This range of LEDs are fairly directional, as the light is emitted from the 'end' of the bulb. If an LED having more all round illumination is required then use 132430 or 132450 - see next page.



Part No.	Intensity Equiv. (W)	No. of LEDs	Colour	Each
<b>132401</b>	21	19	Amber	<b>£7.84</b>
<b>132402</b>	21	19	Red	<b>£7.84</b>



12V LED towers that are replacements for 12V 21W BA15s bulbs. **Suitable for negative or positive earth vehicles.** Designed to last 30,000 hours (25 times longer than conventional bulbs). **Will also operate at 24V.** Slightly smaller than a conventional bulb.



**Amber:** 25 Lumens. 0.18A current draw compared to 1.75A with conventional bulbs. A suitable flasher relay to operate these LEDs is our part 140107 - p.140.

**Red:** Takes 10% of current compared with conventional bulbs. Useful as a brake light / rain light / fog light or as a bright tail lamp.

Part No.	Intensity Equiv. (W)	Polarity	Colour	Each
<b>132430</b>	21	-ve or +ve	Amber	<b>£10.88</b>
<b>132450</b>	21	-ve or +ve	Red	<b>£10.88</b>

## BA15s - BULB HOLDERS



Single contact, single screw connection. 17mm OD x 22mm long (excluding connector post).

**132003**  
**£3.00**



Single contact, 2 screw connections (1 ground).

**132004**  
**£4.55**



BA15s bulb holder with 120mm flying lead. Plated steel with fixing bracket having 2 x 4mm holes on 26mm centres.

**132035**  
**£2.96**

contd...

## BA15s - BULB HOLDERS (contd)



BA15s brass bulb holder. A suitable replacement for the holder in our rubber bodied indicator lamps 170607 - see p.190.

**132038**

**£16.54**



Single contact bulb holder for the Lucas L1130 range of lights. (Lucas 574383).

**132041**

**£14.47**



Single contact bulb holder for the Lucas L488 range of lights. Replica Lucas item.

**132012**

**£7.40**



Single contact bulb holder for the Lucas L594 range of lights. Replica Lucas item.

**132010**

**£6.89**



Repair bulb holder - single contact version. Useful for repairing reflectors with damaged/missing bulb holders. Will fit into 22mm diameter hole. Bulb holder edge is then peened over to attach.

**132014**

**£7.40**

## BA15d - STANDARD BULBS

15mm diameter metal cap, double contact, parallel pins.



### Small Globe.

Part No.	Volts	Watts	Fila-ment	Type	Each	10
<b>130701</b>	6	5	Single	206	<b>£0.74</b>	<b>£6.38</b>
<b>130702</b>	6	10	Single	244D	<b>£0.89</b>	<b>£7.57</b>
<b>130703</b>	12	5	Single	209	<b>£0.74</b>	<b>£6.38</b>
<b>130704</b>	12	10	Single	210	<b>£0.93</b>	<b>£7.90</b>



### Medium Globe.

Part No.	Volts	Watts	Fila-ment	Type	Each	10
<b>130801</b>	6	18	Single	319	<b>£1.01</b>	<b>£8.42</b>
<b>130804</b>	6	21	Single	319	<b>£1.01</b>	<b>£8.42</b>
<b>130802</b>	12	21	Single	335	<b>£0.68</b>	<b>£5.88</b>
<b>130803</b>	12	21/5	Double	381	<b>£0.93</b>	<b>£7.90</b>



### Large Globe.

Part No.	Volts	Watts	Fila-ment	Type	Each	10
<b>130901</b>	12	36/36	Double	171	<b>£2.91</b>	<b>£24.78</b>
<b>130902</b>	12	36	Single	5	<b>£2.98</b>	<b>£25.28</b>
<b>130903</b>	12	45	Single	27	<b>£3.62</b>	<b>£30.84</b>

## BA15d - HALOGEN BULBS



15mm diameter metal cap, double contact, parallel pins. Overall length: 55mm.

Part No.	Volts	Watts	Filament	Type	Each
<b>130908</b>	6	25/25	Double	-	<b>£12.92</b>
<b>130906</b>	12	45/40	Double	171	<b>£12.92</b>

## BA15d - BULB HOLDERS



Parallel pins, double contacts, 2 screw connections. 17mm outside diameter, body length 23mm, total length including screw terminals 32mm.

**132002**

**£3.57**



Nickel plated steel BA15d bulb holder with bracket having 2 x 4mm holes on 27mm centres. Supplied with 2 x 15cm wire tails.

**132042**

**£4.10**



BA15d bulb holder with 120mm flying leads. Plated steel with fixing bracket having 2 x 4mm holes on 26mm centres.

**132034**

**£3.58**



Double contact brass bulb holder, with 36mm flange with three mounting holes, 2 screw connections. The overall height is 32.5mm and base diameter 39mm.

**132007**

**£5.60**



Empty BA15D level pin base. Useful for making plugs to fit BA15D bulb holders or to make homemade bulbs!

**132045**

**£2.60**



Traditional bulb holder plug to connect into a range of vintage lamps. Wires into the plug are retained by small Allen key grub screws. Nickel plated brass construction. 7mm hole diameter for cable entry.

**132050**

**£15.12**

## BAY15d - STANDARD BULBS (STOP/TAIL)

15mm diameter metal cap, double contact, offset pins.



**Small Globe.** Useful when trying to fit double filament bulbs into confined spaces.

Part No.	Volts	Watts	Fila-ment	Type	Each	10
<b>131005</b>	12	21/5	Double	380m	<b>£2.00</b>	<b>£17.84</b>



**Medium Globe.**

Part No.	Volts	Watts	Fila-ment	Type	Each	10
<b>131001</b>	6	21/5	Double	384	<b>£0.93</b>	<b>£7.90</b>
<b>131002</b>	12	21/5	Double	380	<b>£0.69</b>	<b>£6.07</b>

## BAY15d - LED BULBS

15mm diameter metal cap, double contact, offset pins.



**19 LEDs.** Similar in intensity to 21W bulbs. Fit standard 15mm bulb holders. 46mm long, 25mm diameter at LED end. This range of LEDs are fairly directional, as the light is emitted from the 'end' of the bulb. If an LED having more all round illumination is required then use 132440 - below.

Part No.	Intensity Equiv. (W)	No. of LEDs	Colour	Each
<b>132404</b>	21	19	Red	<b>£7.84</b>



12V red LED tower that is a replacement for 12V 21/5W BAY15d stop/tail bulbs. **Suitable for negative earth vehicles only.** Designed to last 30,000 hours (25 times longer than conventional bulbs). **Will also operate at 24V.** Slightly smaller than a conventional bulb. 2 sets of LEDs, one set for tail lights, one for brake lights. Takes 10% of current compared with conventional bulbs.



Part No.	Intensity Equiv. (W)	Polarity	Colour	Each
<b>132440</b>	21/5	-ve	Red	<b>£10.88</b>

## BAY15d - BULB HOLDERS



Nylon bulb holder to take BAY15d (double contact, offset pin) bulbs. Bulb holder fits 28mm diameter holes (with appropriate cut outs for bayonet lugs) up to approximately 2mm thick. Electrical connection via 3 x 6.3mm blade terminals.

**132032**

**£5.94**



Offset pins, double contacts, 2 screw connections.

**132001**

**£3.57**



BAY15d (offset pin) bulb holder with 120mm flying leads. Plated steel with fixing bracket having 2 x 4.5mm holes on 32mm centres.

**132036**

**£2.96**



Bulb holder for the Lucas L1130 range of lights. Double contact to take BAY15d (offset pin) bulbs. (Lucas 574380).

**132020**

**£14.47**



Double contact BAY15d bulb holder for Lucas L488 range of lights. Replica Lucas item.

**132013**

**£7.40**



Double contact BAY15d bulb holder for Lucas L594 range of lights. Replica Lucas item.

**132011**

**£6.89**



Repair bulb holder - double contact version. Useful for repairing reflectors with damaged/missing bulb holders. Will fit into 22mm diameter hole. Bulb holder edge is then peened over to attach.

**132015**

**£7.40**

## BA20s - BOSCH - STANDARD BULBS

20mm diameter metal cap, single contact, parallel tabs.



Part No.	Volts	Watts	Fila-ment	Type	Each	10
<b>131101</b>	6	35	Single	393	<b>£2.98</b>	<b>£25.28</b>
<b>131102</b>	12	45	Single	397	<b>£2.64</b>	<b>£22.42</b>

## BA20d - BOSCH - STANDARD BULBS

20mm diameter metal cap, double contact, parallel tabs.



Part No.	Volts	Watts	Fila-ment	Type	Each	10
<b>131200</b>	6	35/35	Double	393	<b>£2.98</b>	<b>£25.28</b>
<b>131201</b>	6	45/40	Double	390	<b>£2.98</b>	<b>£25.28</b>
<b>131202</b>	12	45/40	Double	396	<b>£3.57</b>	<b>£30.59</b>
<b>131203</b>	12	45	Single	397	<b>£3.57</b>	<b>£30.59</b>

## BA20d - BOSCH - SEMI-HALOGEN BULB

20mm diameter metal cap, double contact, parallel tabs.



Part No.	Volts	Watts	Fila-ment	Type	Each	10
<b>131204</b>	6	35/35	Double	1048	<b>£4.77</b>	<b>£40.46</b>

## P36s - BRITISH PRE-FOCUS - HALOGEN BULB

36mm diameter metal cap, single contact.



Part No.	Volts	Watts	Fila-ment	Type	Each	10
<b>131301</b>	12	48	Single	185	<b>£3.14</b>	<b>£26.63</b>



## P36d - BRITISH PRE-FOCUS - STANDARD BULBS

36mm diameter metal cap, double contact.



Part No.	Volts	Watts	Fila-ment	Type	Each	10
<b>131401</b>	6	30/24	Double	312	<b>£3.96</b>	<b>£33.74</b>
<b>131402</b>	12	50/40	Double	414	<b>£4.57</b>	<b>£40.99</b>
<b>131403</b>	12	48	Single	326	<b>£3.14</b>	<b>£26.63</b>

## P36d - BRITISH PRE-FOCUS - HALOGEN BULBS

36mm diameter metal cap, double contact.



Part No.	Volts	Watts	Filament	Type	Each
<b>131404</b>	6	35/35	Double	312	<b>£13.57</b>
<b>131405</b>	12	60/55	Double	414	<b>£13.57</b>

## BRITISH PRE-FOCUS BULB HOLDER



Bulb holder/connector to fit the rear of British Pre-Focus reflectors. Has 3 leads 80cm long with bullet connectors, and headlamp shell sealing grommet.

**132026**  
**£10.41**

## P43t - H4 - HALOGEN BULBS



Part No.	Volts	Watts	Filament	Type	Each
<b>131501</b>	6	60/55	Double	476	<b>£8.55</b>
<b>131504</b>	6	35/35	Double	-	<b>£8.35</b>
<b>131502</b>	12	60/55	Double	472	<b>£3.57</b>
<b>131503</b>	12	100/80	Double	484	<b>£8.13</b>

## P45t - STANDARD BULBS



Part No.	Volts	Watts	Filament	Type	Each
<b>131601</b>	6	45/40	Double	423	<b>£3.57</b>
<b>131603</b>	12	45/40	Double	410	<b>£2.71</b>

## P45t - H4 - HALOGEN BULBS



Part No.	Volts	Watts	Filament	Type	Each
<b>131604</b>	12	60/55	Double	12	<b>£4.64</b>
<b>131605</b>	12	100/80	Double	485	<b>£9.86</b>

## H4 CONNECTORS



Ceramic H4 connecting socket with 100mm flying leads. For use with P43t and P45t bulbs and sealed beam lamps. (Useful if your headlamp bulbs get really hot, as the ceramic holder will not melt).

**132029**  
**£3.07**



90° connecting socket for connecting to H4 (P43t and P45t) bulbs and sealed beam lamps. Supplied with terminals. Spare terminals available (030303 - p.47).

**050502**  
**£2.28**



Straight connecting socket for connecting to H4 (P43t and P45t) bulbs and sealed beam lamps. Supplied with terminals. Spare terminals are available (050207 - p.48).

**050501**  
**£1.91**

## H7 - PX26d - HALOGEN BULB



Part No.	Volts	Watts	Filament	Type	Each
<b>131640</b>	12	55	Single	477	<b>£2.96</b>

## H7 CONNECTOR



Ceramic H7 connecting socket with 100mm flying leads.

**132030**  
**£2.43**

## H3 - PK22s - HALOGEN BULBS



Part No.	Volts	Watts	Filament	Each
131619	12	35	Single	£4.47
131620	12	55	Single	£3.96
131621	24	70	Single	£4.63

## H2 - X511 - HALOGEN BULB



Part No.	Volts	Watts	Filament	Each
131618	12	55	Single	£4.42

## H1 - P14.5s - HALOGEN BULB



Part No.	Volts	Watts	Filament	Each
133001	12	55	Single	£3.21

## H1 CONNECTOR



Ceramic H1 connecting socket with 100mm flying leads.

**132028**  
**£2.71**

## APF - AMERICAN PRE-FOCUS - STANDARD BULB



Part No.	Volts	Watts	Filament	Each
131630	12	45/45	Double	£3.96

## MARCHAL HEADLAMP BULBS



Part No.	Volts	Watts	Colour	Type	Each	10
132103	6	40/45	Clear	117	£8.18	£69.50
132105	6	40/45	Amber	117	£8.80	£74.84
132102	12	40/45	Clear	217	£7.55	£64.16
132104	12	40/45	Amber	217	£8.18	£69.50

## GRAIN OF WHEAT BULBS



A T1 white grain of wheat wire ended filament bulb (3mm diameter x 5.5mm long). Supplied with 150mm lead for for easy connection to circuits. Ideal for use in a various panel and switch lighting applications.

Part No.	Volts	Current (mA)	Each	10
132210	6	60	£0.97	£8.80
132211	12	80	£0.97	£8.80

## PANEL BULB - CAPLESS



**W2 x 4.6d.** 12V capless bulbs suitable for instrument illumination etc. "Cap" dimensions 2mm x 4.6mm.

Part No.	Volts	Watts	Each	10
132201	12	1.2	£0.66	£5.71

## SIDE/INSTRUMENT BULBS - T10 - CAPLESS



**W2.1 x 9.5d** (T10) capless bulbs. Types available: 12V 5W for side light use and 12V 2W for instrument lighting. 6V 3W for general use.

Part No.	Volts	Watts	Type	Each	10
<b>132208</b>	6	3	502	<b>£0.98</b>	<b>£8.34</b>
<b>132205</b>	12	2	297	<b>£0.82</b>	<b>£6.96</b>
<b>132202</b>	12	5	501	<b>£0.66</b>	<b>£5.71</b>

## T10 BULB HOLDERS



Insulated T10 (W2.1 x 9.5d) bulb holder. 2 x 6.3mm blade connections. 12.0mm OD.

**132018**  
**£1.03**



Insulated T10 (W2.1 x 9.5d) bulb holder with leads to fit  $\frac{3}{8}$ " (16mm) panel hole. Suitable for side light apertures in 7" halogen conversions and instrument lighting.

**132022**  
**£4.62**

## INDICATOR BULBS - CAPLESS



**W2.1 x 9.5d.** For use with indicators.

Part No.	Volts	Watts	Colour	Type	Each	10
<b>132204</b>	12	21	Clear	921	<b>£1.31</b>	<b>£11.01</b>
<b>132206</b>	12	21	Amber	921A	<b>£1.84</b>	<b>£15.70</b>



## INDICATOR BULBS - T20 - CAPLESS



**W3 x 16d.** For use with indicators.

Part No.	Volts	Watts	Colour	Type	Each	10
<b>132203</b>	12	21	Clear	582	<b>£1.50</b>	<b>£12.89</b>

## FESTOON BULBS



Part No.	Volts	Watts	Size (mm)	Type	Each	10
<b>131701</b>	6	5	11 x 38	253	<b>£0.87</b>	<b>£7.34</b>
<b>131801</b>	6	10	11 x 42	258	<b>£0.87</b>	<b>£7.34</b>
<b>131901</b>	6	15	15 x 42	266	<b>£0.87</b>	<b>£7.34</b>
<b>131709</b>	12	3	6 x 36	268	<b>£0.87</b>	<b>£7.34</b>
<b>131708</b>	12	3	8 x 36	256	<b>£0.87</b>	<b>£7.34</b>
<b>131711</b>	12	10	11 x 30	269	<b>£0.87</b>	<b>£7.34</b>
<b>131712</b>	12	10	11 x 35	272	<b>£0.87</b>	<b>£7.34</b>
<b>131702</b>	12	5	11 x 38	239	<b>£0.87</b>	<b>£7.34</b>
<b>131802</b>	12	5	11 x 42	258	<b>£0.87</b>	<b>£7.34</b>
<b>131803</b>	12	10	11 x 42	264	<b>£0.87</b>	<b>£7.34</b>
<b>131905</b>	12	10	15 x 42	265	<b>£0.87</b>	<b>£7.34</b>
<b>131903</b>	12	15	15 x 42	267	<b>£0.87</b>	<b>£7.34</b>
<b>131904</b>	12	21	15 x 42	273	<b>£0.87</b>	<b>£7.34</b>

## FESTOON BULB HOLDER



Bulb holder *suitable for taking 35mm long festoon bulbs*. Single screw mounting hole.

**132021**  
**£7.23**



## FREE-STANDING LAMPS



4½" replica Bates free-standing headlamp - black. Supplied with 12V 35/35W bulb (PX15d). Blue high beam warning lamp built in. Lens diameter 107mm. Lamp diameter (including bezel) 124mm. 250mm flying leads. Adjustable mounting post with 10mm diameter fixing bolt.

**170407**

**£44.00**



As above, but in chrome.

**170408**

**£44.00**



Classic mini driving lamps. High power 5" (125mm) diameter driving or spot lamps. Highly polished chrome. Fitted with 12V H3 55W bulbs. Supplied as a pair in a box. E-marked.

**170414**

**£50.20 / pair**



Classic style driving lamps. High power 5.5" (140mm) diameter driving or spot lamps (approx 58mm deep). Highly polished chrome. Fitted with 12V H3 55W bulbs. Supplied with durable plastic Wipac covers. E-marked. Supplied as a pair in a box.

**170413**

**£39.63 / pair**



12V classic free-standing headlamps fitted with integral sidelight and supplied with wiring harness and all bulbs, ready to connect. Headlamp bulbs are 12V P43T H4 60/55W (131502 - p.176) and sidelight bulbs are 12V 5W capless W2.1x9.5D (132202 - p.180). 6V versions of these bulbs are also available. 7" version available in either polished stainless steel or black finish with a polished rim. 5¾" version available in polished stainless steel or all black. 7" units approximately 185mm dia. and 155mm deep. 5¾" units approximately 155mm dia. and 125mm deep. All are E-marked.



Part No.	Size	Finish	Each
<b>170401</b>	7"	S/Steel	<b>£106.97</b>
<b>170403</b>	5¾"	S/Steel	<b>£98.85</b>
<b>170404</b>	5¾"	All Black	<b>£98.85</b>



Wipac 4X4 offroad driving lamps. High power 12V, 100W, 8" diameter halogen lamps. Available with black body and black rim. Supplied with armoured cable and fitted plastic stone guard. Sold as pair only.

**170411**

**£82.10 / pair**

## 5¾" LIGHT UNITS



12V 5¾" sealed beam unit. 37.5/60W. **For UK use.**

**170108**

**£18.80**



5¾" headlamp. Replaces LUB222. This unit has a glass lens with metal reflector and can be fitted with a H1 bulb (p.178 - not supplied). No provision for pilot lamp. These units are physically interchangeable with sealed beam units. **UK use only** as they dip to the left.

**170118**

**£24.87**

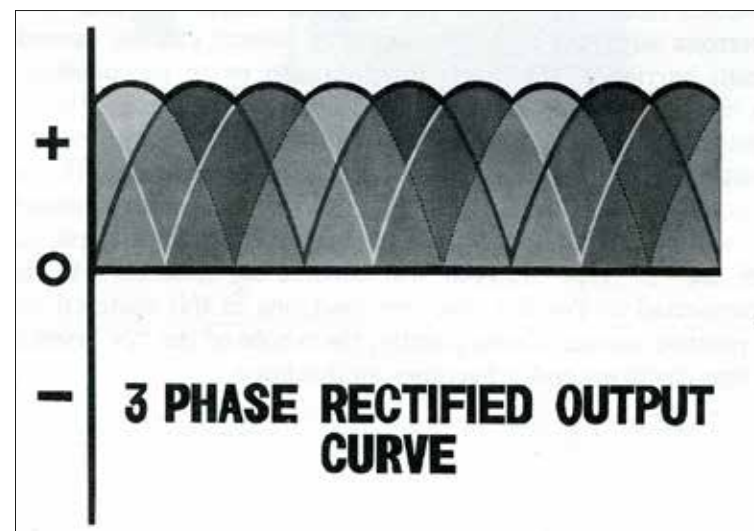

## 7" LIGHT UNITS



Wipac Quadoptic light units. A slightly cheaper range than the Lucas lamp units which consist of glass lenses with plastic reflectors available with or without hole (12mm diameter) for pilot light bulb holder. These units take a H4 P43t bulb (not supplied - see p.176). **For UK use.** E-marked. The required pilot light bulb holder is our part 132018 (p.180) which requires a capless W2.1 x 9.5d type bulb (p.180).and is connected via 2 x 6.3mm blade terminals.

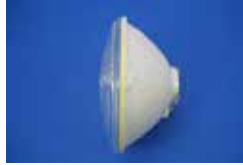

Part No.	Type	Suitable Harness	Each
<b>S6010</b>	With pilot	170204	<b>£21.08</b>
<b>S6008</b>	Without pilot	170201	<b>£21.08</b>



Wipac classic fluted reflector light units. Consist of fluted plastic reflectors with clear polycarbonated lenses. (These lamp units are often used when the look of the vehicle is of top priority as they have a classic look). Available with or without pilot light bulb holder. All units take a H4 P43T bulb (not supplied - p.176) and the pilot requires a capless W2.1 x 9.5d type bulb (p.180). E-marked.



Part No.	Type	Suitable Harness	Each
<b>S6072</b>	With pilot	170204	<b>£31.05</b>
<b>S6071</b>	Without pilot	170201	<b>£31.05</b>



Newly manufactured Lucas 7" British Pre-Focus light units (LUB300) available with or without provision for a pilot light bulb holder. Have glass lens with Lucas logo and metal reflector. Requires a British Pre Focus headlamp bulb and if required, pilot lamp bulb holder 132008. Not E-marked. UK use only (dip to the left).



Part No.	Type	Each
<b>170122</b>	With pilot	<b>£38.78</b>
<b>170123</b>	Without pilot	<b>£44.56</b>



Replica version of Lucas P700 7" tripod light unit. These units have a metal reflector and glass lens, and are fitted with a 12V 5W pilot lamp. They take a H4 P43t bulb (not supplied - p.178). Reflector and lens are symmetrical about the vertical centre line and so usable in both in UK and Europe as dipping is up/down. No E-marking. Comes with rubber dust cap for bulb.

<b>P700</b>
<b>£38.97</b>

## HEADLAMP PARTS



Mounting bowl assembly for 7" headlamp units. Comprises plastic headlamp unit mounting bowl and steel rim with **two screw adjusters** (for adjusting beam height). This unit will fit any of the 7" light units in the 7" Light Unit section (previous page). When fixing the bowl assembly into the body shell, a rubber mounting gasket is recommended.

<b>170304-P</b>
<b>£31.44</b>



7" plastic headlamp mounting ring with chromed steel headlamp unit retaining ring. Useful for mounting headlamps in confined spaces. Takes all 7" light units. Supplied with mounting gasket and screws.

<b>170102</b>
<b>£21.35</b>



Lucas F700 7" headlamp bowl kit. This kit contains the following parts to make 2 complete bowls. 2 x Lucas 7" 3 screw headlamp bowls, complete with light unit retaining rings. 2 x headlamp connecting looms. 2 x Headlamp mounting shell gaskets (170307). 2 x Headlamp dust excluders (170309). These bowl assemblies will fit any of the 7" light units in the 7" light unit section.

<b>LUCAS F700</b>
<b>£44.10</b>

contd...



## HEADLAMP PARTS (contd)



Plastic headlamp bowl to take 7" light units. Made from tough black plastic. Comes complete with chrome-plated lens retaining bezel, bodywork sealing gasket, cable grommet and retaining screws.

**170101**

**£20.08**



Chrome-plated rims to fit 7" headlamp bowls 170101 (above) and headlamp mounting rings 170102 - p.187. Held in place with a retaining screw. Available in two diameters. Rim 170301 has an outside diameter of approximately 8½" and a more gently curved profile. 170302 has a diameter of 8" and is 'squarer' in profile.



Curved Profile

Square Profile

Part No.	Type	OD (in)	Each
<b>170301</b>	Curved profile	8½	<b>£21.79</b>
<b>170302</b>	Square profile	8	<b>£20.19</b>



Plastic headlamp bowl to take 5¾" light units. Made from tough black plastic. Comes complete with chrome-plated lens retaining bezel, bodywork sealing gasket, cable grommet and retaining screws.

**170106**

**£24.91**



Black plastic rim to fit 5¾" headlamp bowl 170106 (above).

**170303**

**£10.62**



Lucas 5¾" chrome rim to fit various classic bikes, such as BSA C15/B40, Bantams, Triumph Tiger Cubs, TR6/T100C etc. (This rim can also be adapted to fit cars having 5¾" lamps). Lucas part number 534343.

**170311**

**£13.31**



Lucas headlamp dust excluder. Fits under the headlamp rim to keep out dust. Fits most 7" headlamps. OEM: LUCAS 552906.

**170309**

**£5.66**



Rubber mounting gasket for use with 2 screw adjuster Lucas 7" mounting bowl (170304 - p.185), but can be used for other applications. Approximate dimensions are 145mm ID, 210mm OD, 32mm wide.

**170305**

**£5.08**



Rubber mounting gasket for use with 2 screw adjuster Lucas 7" mounting bowl (170304 - p.185), but can be used for other applications. Approximate dimensions are 145mm ID, 200mm OD, 27mm wide.

**170306**

**£5.08**



Headlamp adjuster kit for the Lucas steel mounting bowl assembly (170304 - p.185). Screws are approx 36mm long.

**LU60600427**

**£3.30**



W-clips. Used to hold light units into headlamp shells.

**170410**

**£0.98**

## HEAD/FOG LAMP RELAY KIT



Allows headlamps or fog lamps to be switched via a relay. This kit can be used to upgrade cars that do not have a relay in the circuit or be used to simply add fog lamps. The kit contains: 30A fused relay, relay connection socket, nickel plated toggle switch, switch bracket, 4 lengths of cable (1 x 5m, 3 x 1m), electrical terminals.

**170950**

**£15.23**

## HEADLAMP HARNESSSES



Headlamp harness suitable for all headlight types without integral sidelights. Comes with headlamp connecting plug, 80cm of cables, sleeving, headlamp shell grommet and bullet connectors.

**170201**

**£7.47**



Headlamp harness suitable for metal reflectors, with hole for clip-in sidelight bulb holder. Comes complete with headlamp connecting plug, rubber dust cover, separate sidelight bulb holder, 1m of cables, sleeving, headlamp shell grommet and bullet connectors.

**170203**

**£14.51**



Headlamp harness suitable for headlight types with integral sidelights connected via 2 x 6.3mm blade terminals. Comes with headlamp connecting plug, 70cm of cables, sleeving, headlamp shell grommet and bullet connectors.

**170204**

**£8.04**

## INDICATOR LAMPS



Lucas L488 indicator lamp. 72mm diameter rubber base with 54mm diameter flat amber glass lens. Supplied with 12V, 21W bulb. Overall length approx. 100mm including lens. Spare bulb holder, chrome rim, rubber body and lens (all p.205) available separately.

**171010**

**£21.62**



Wipac manufactured Land Rover style indicator light. Approximately 70mm in diameter. Requires 35mm panel hole. E-marked. Takes a BA15s bulb (not supplied - see p.167 & 168). Supplied with 90cm lead with bullet connections.

**170740**

**£8.85**



Lucas L539 indicator lamp. 83mm diameter chromed metal base with 65mm diameter domed amber plastic lens. Supplied with 12V, 21W bulb, 600mm leads with bullet terminals and sealing gasket. Overall length approx. 75mm including lens.

**171012**

**£34.80**



Lucas L594 indicator lamp. 72mm diameter rubber base with 54mm diameter domed amber glass lens. Supplied with 12V, 21W BA15s bulb. Overall length approx. 100mm including lens. E-marked. Spare bulb holder, chrome rim, rubber body and lens (see p.205 & 206) available separately.

**171009**

**£20.22**



Pattern version of Lucas L594 with amber plastic lens. Supplied with bulb and 20cm of cable with bullet terminals. E-marked. 72mm diameter rubber base with 54mm diameter lens. Overall length approx. 100mm

**170602**

**£12.18**



Flush-fit version (with a plastic) lens of Lucas L594 indicator. Fitted with 12V 21W festoon bulb & stainless steel ring (chrome rim available separately - see p.205). E-marked. 72mm diameter rubber base with 54mm diameter lens.

**170605**

**£9.69**



A good reproduction of the Lucas L632 combined side/indicator lamp fitted to a variety of vehicles. Supplied with 500mm leads with bullet terminals, sealing gasket and bulbs (1 x BA15s 21W & 1 x BA9s 4W).

**170634**

**£36.41**



Lucas L677 combined side/indicator lamp. Fits many vehicles including MG's, Triumphs, Aston Martin etc. Supplied with 500mm leads with bullet terminals and sealing gasket. E-marked. Requires bulbs. 21W BA15s indicator bulb (p.167 & 168) and 4W BA9s side light bulb (p.165 & 166).

**170632**

**£22.07**

contd...

## INDICATOR LAMPS (contd)



Lucas L584 combined side/indicator lamp. Fits many vehicles including Triumph Herald, Jensen Interceptor, Austin Healey Sprite, MG Midget etc. Supplied with 500mm leads with bullet terminals and sealing gasket. E marked. Has an amber glass dome within the lamp assembly, so the indicator bulb flashes orange. Requires bulbs. 21W BA15s indicator bulb (p.167 & 168) and 4W BA9s side light bulb (p.165 & 166).

Part No.	Type	Each
<b>170630</b>	Left hand	<b>£30.19</b>
<b>170631</b>	Right hand	<b>£30.19</b>



Lucas L691 indicator lamp. 83mm diameter chromed metal base with 80mm diameter domed amber plastic lens. Supplied with 12V, 21W bulb, 600mm leads with bullet terminals and sealing gasket. Overall length approx. 90mm including lens. E-marked. Spare lens available separately (p.207).

<b>171011</b>
<b>£24.53</b>



Lucas L794 indicator lamp. Supplied with 500mm leads with bullet terminals, sealing gasket and bulb. Approx 82mm diameter. E-marked. Spare lens available separately (p.206).

<b>171018</b>
<b>£35.93</b>



Rubber bodied marker lamp that can be used as a discrete indicator lamp. Body diameter 46mm, lens diameter 35mm. Overall length 91mm Supplied with mounting bracket. Requires BA15s bulb. Recommended for use with 19 LED bulb, part number 132401 (p.168). E-marked. Spare bulb holders available (132038 - p.170).

**Please note: This lamp unit was designed for use with standard 5W bulbs. If used with standard 21W bulbs in a non-flashing mode, damage to the light unit will occur due to the heat generated.**

<b>170607</b>
<b>£21.41</b>



Matt black bullet shape body, mounted on threaded up-stand. Body diameter 49mm. Body length with lens 69mm. 8 mounting stud 35mm long. Up-stand 15mm. Supplied with 20cm leads with bullet connectors. Rubber sealing gasket between lens and body. Supplied with 12V BA15s 23W bulb (130405 - p.167)

<b>170649</b>
<b>£16.15</b>



Chrome bullet shape body, mounted on flush-fit threaded up-stand. Body diameter 57mm. Body length with lens 78mm. M8 mounting stud. Supplied with 23cm leads with bullet connector. Rubber sealing gasket between lens and body. Supplied with 12V BA15s,10W, small globe bulb (130404 - p.167).

<b>170647</b>
<b>£13.21</b>



Chrome bullet shape body, mounted on threaded up-stand. Body diameter 49mm. Body length with lens 73mm. M8 mounting stud 35mm long. Up-stand 15mm. Supplied with 20cm leads with bullet connectors. Rubber sealing gasket between lens and body. Supplied with 12V BA15s, 10W, small globe bulb (130404 - p.167).

<b>170648</b>
<b>£13.21</b>



Replacement bulb holders for Lucas L1130 style lamps, to convert them to having a white side light and an amber indicator. Sold as a pair. Supplied with bulbs. Replacement bulbs available (side light 132202 & indicator 132206 - both p.180). Supplied with mounting bolts and washers.

<b>132031</b>
<b>£70.50 / pair</b>

### YOU MAY ALSO BE INTERESTED IN:

- Indicator Kits - p.115 & 116
- Hazard Switch Kits - p.116

## INDICATOR REPEATER LAMPS



Circular **12V** repeater lamp. 19mm diameter lens, 27mm including rubber surround. Requires 20mm diameter hole. Supplied with 180mm tails. E-marked.

**171024**

**£10.69**



Circular **24V** repeater lamp. 19mm diameter lens, 27mm including rubber surround. Requires 20mm diameter hole. Supplied with 180mm tails. E-marked.

**171025**

**£11.95**



Lucas L734 indicator repeater lamp. 76mm x 24mm. 2 x fixing studs on 42mm centres. Supplied with gasket, 100 cm leads and 12V BA9s bulb.

**171023**

**£17.84**

## SIDE LAMPS



Lucas L584 combined side/indicator lamp. Fits many vehicles including Triumph Herald, Jensen Interceptor, Austin Healey Sprite, MG Midget etc. Supplied with 500mm leads with bullet terminals and sealing gasket. E marked. Has an amber glass dome within the lamp assembly, so the indicator bulb flashes orange. Requires bulbs. 21W BA15s indicator bulb and 4W BA9s side light bulb.

Part No.	Type	Each
<b>170630</b>	Left hand	<b>£30.19</b>
<b>170631</b>	Right hand	<b>£30.19</b>



Wipac manufactured Land Rover style side light. Approximately 70mm in diameter. Requires 35mm panel hole. E-marked. Takes a BA15s bulb (not supplied - p.169). Supplied with 90cm lead with bullet connections.

**170640**

**£8.85**



Chrome plated vintage style side light. Fitted with 12V BA9s bulb. Has frosted glass and red illuminated medallion on top surface. Approximately 55mm in diameter by 65mm long. Complete with 30cm lead with brass bullet.

**170639**

**£49.30**



Lucas L488 side lamp. 72mm diameter rubber base with 54mm diameter flat glass lens. Available in either single pole (5W) or double pole (21/5W) for use as combined side light/indicator. Overall length approx. 100mm including lens. Supplied with bulbs. Spare bulb holder, chrome rim, rubber body and lens (all p.205) available separately.



Part No.	Type	Each
<b>170610</b>	Side light (single pole)	<b>£21.62</b>
<b>170621</b>	Side/Indicator (double pole)	<b>£21.62</b>



Lucas L539 side lamp. 83mm diameter chromed metal base with 65mm diameter domed plastic lens. Supplied with 12V, 21W bulb, 600mm leads with bullet terminals and sealing gasket. Overall length approx. 75mm including lens. A double pole version of this lamp is also available, fitted with a BAY15d 5/21W 12V bulb. This lamp can therefore be used as a side light and also an indicator light.

Part No.	Type	Each
<b>170612</b>	Side light (single pole)	<b>£34.80</b>
<b>170641</b>	Side/Indicator (double pole)	<b>£34.80</b>



Pattern version of Lucas L594 with plastic lens. Supplied with bulb and 20cm of cable with bullet terminals. E-marked. 72mm diameter rubber base with 54mm diameter lens. Overall length approx. 100mm.

**170601**

**£11.60**



A good reproduction of the Lucas L490 side lamp. Supplied with 1m long cables, PVC sleeved, with bullet connectors. Approx 30mm diameter x 50mm long. Requires BA9s bulb (p.167 & 168).

**170637**

**£36.06**

contd...



## SIDE LAMPS (contd)



Lucas L594 side lamp. 72mm diameter rubber base with 54mm diameter domed glass lens. Supplied with 12V, 5W bulb, (or 21/5W in double pole version). Overall length approx. 100mm including lens. E-marked. Spare chrome rim (p.205), bulb holders, lens and rubber body (all p.208) available separately.



Part No.	Type	Each
<b>170609</b>	Side light (single pole)	<b>£20.22</b>
<b>170622</b>	Side/Indicator (double pole)	<b>£20.22</b>



Flush-fit version of Lucas L594 side lamp with stainless steel ring and single filament 5W festoon bulb. (Chrome rim available separately - p.205).

<b>170604</b>
<b>£9.69</b>



Lucas L691 side lamp. 83mm diameter chromed metal base with 80mm diameter domed plastic lens. Supplied with 12V, 5W bulb, 600mm leads with bullet terminals and sealing gasket. Overall length approx. 90mm including lens. E-marked. Spare lens available separately (p.207).

<b>170611</b>
<b>£24.53</b>



Rubber bodied marker lamp that can be used as a discrete side lamp. Body diameter 46mm, lens diameter 35mm. Overall length 91mm. Supplied with mounting bracket. E-marked. Requires 12V, 5W BA15s bulb 130403 (p.167).

<b>170615</b>
<b>£27.70</b>



Rubber bodied side lamp. 56mm diameter with a slightly curved plastic lens. Requires 30mm diameter panel hole. Overall length 78mm. E-marked. Requires 12V, 5W BA15s bulb 130403 (p.167).

<b>170613</b>
<b>£16.21</b>



Reproduction Lucas L516 side/marker lamp. This lamp takes a 12V BA9s bulb (supplied) and has leads with bullet connectors approx 50cm long. Chrome plated. Lamp diameter approximately 33mm, length 85mm. Spare lens (177013 - p.207) available separately.

<b>170638</b>
<b>£38.80</b>



Lucas L513 side lamps. Available in either single pole (side light only) or double pole (side/indicator) versions. Come with rubber sealing O-ring. Single pole version requires BA15s type bulb (p.167 & 168). Double pole version requires BAY15d type bulb (p.173).

Part No.	Type	Each
<b>170635</b>	Side light (single pole)	<b>£54.92</b>
<b>170636</b>	Side/Indicator (double pole)	<b>£54.92</b>



Lucas L1130 side/indicator lamp with double pole bulb holder and plastic lens. Supplied with 12V, 21/5W bulb (BA15d).

<b>170618</b>
<b>£91.04</b>



Pattern version of Lucas 1130 side/indicator lamp made from chrome plated pressed brass, having a chrome rim and frosted glass lenses. Plain body containing two separate bulb holders housing capless bulbs, one amber (132206) for indicators and one (132202) for side light. Lamp supplied with flying leads, ready to fit.

<b>170619-IND</b>
<b>£92.17</b>



As above but with the body having a red dot round, that illuminates when the lamp is switched on.

<b>170619-RD-IND</b>
<b>£103.80</b>



As above but having a traditional bulb holder housing a BA15d double filament 21/5W bulb (130803). Please note that when this lamp is used as an indicator, it will flash with a white light, not amber.

<b>170619-RD</b>
<b>£86.81</b>



Replacement bulb holders for above Lucas L1130 style lamps, to convert them to having a white side light and an amber indicator. Sold as a pair. Supplied with bulbs. Replacement bulbs available (side light 132202 & indicator 132206 - both p.180). Supplied with mounting bolts and washers.

<b>132031</b>
<b>£70.50 / pair</b>



## SIDE LAMPS (contd)



A good reproduction of the Lucas L489 side lamp fitted to a variety of vehicles. Supplied with 500mm leads with bullet terminals, sealing gasket and 12V BA9s bulb. Approximately 60mm in diameter.

**170645**  
**£56.13**

## REAR LAMPS



Wipac manufactured Land Rover style stop/tail light. Approximately 70mm in diameter. Requires 35mm panel hole. E-marked. Takes a BAY15d bulb (not supplied - p.173). Supplied with 90cm lead with bullet connections.

**170540**  
**£8.85**



Lucas L551 stop/tail lamp. 96mm diameter chromed metal base with 80mm diameter domed plastic lens. Supplied with 12V, 5W BA9S side bulb & 12V 21W BA15S stop bulb, 600mm leads with bullet terminals and sealing gasket. Overall length approx 95mm including lens. E-marked.

**170513**  
**£59.44**



Combined tail light and indicator light. 77mm diameter by 60mm deep. Black metal case. Comes complete with cable grommet and mounting bolts. Requires 43mm festoon bulbs: 6V - 131801 (10W) & 131901 (15W), 12V - 131802 (5W) & 131904 (21W) - all bulbs p.181.

**170505**  
**£45.33**



Lucas L488 stop/tail lamp. 72mm diameter rubber base with 54mm diameter flat glass lens. Supplied with 12V, 21/5W bulb. Overall length approx. 100mm including lens. Spare bulb holder, chrome rim, rubber body and lens (all p.205) available separately.

**170510**  
**£21.62**



Lucas L539 stop/tail lamp. 83mm diameter chromed metal base with 65mm diameter domed plastic lens. Supplied with 12V, 21/5W bulb, 600mm leads with bullet terminals and sealing gasket. Overall length approx. 75mm including lens.

**170512**  
**£34.80**



Lucas L549 stop/tail lamp. Supplied with 12V, 21/5W bulb and sealing gasket. Spare lens and gaskets available separately - p.207. Base dimensions are 75mm x 135mm.

**170518**  
**£33.66**



Good replica version of the Lucas L582 rear lamp. Black casing with number plate illumination window. Takes a BA15d bulb and is supplied with a 12V 5/21W version, so can be used as a stop/tail light. If fitted with a double contact single filament bulb (130703 - p.171), can be used as tail light only. Case diameter 42mm, lens diameter 55mm, overall lamp length approx 90mm. Requires 20mm diameter mounting hole.

**170525**  
**£60.64**



Lucas L594 stop/tail lamp. 72mm diameter rubber base with 54mm diameter domed glass lens. Supplied with 12V, 21/5W BAY15d bulb. Overall length approx. 100mm including lens. E-marked. Spare chrome rim (p.205), bulb holders, lens and rubber body (all p.206) available separately.

**170509**  
**£20.22**



Pattern version of Lucas L594 with plastic lens. Supplied with bulb and 20cm of cable with bullet terminals. E-marked.

**170603**  
**£11.60**



Flush-fit version of Lucas L594 rear lamp with a plastic lens. Fitted with 12V 21W festoon bulb & stainless steel ring (chrome rim available separately - p.205). (For 6V applications use 6V bulb (131901 - p.181)). E-Marked.

**170606**  
**£9.69**

contd...

## REAR LAMPS (contd)



Lucas L691 stop/tail lamp. 83mm diameter chromed metal base with 80mm diameter domed plastic lens. Supplied with 12V, 21/5W bulb, 600mm leads with bullet terminals and sealing gasket. Overall length approx. 90mm including lens. E-marked. Spare lens available separately - p.207.

**170511**

**£24.53**



Reproduction Lucas ST38 'Pork-Pie' light. Three bulb holders; two for stop lights and one for tail. Has side window for number plate illumination. 90mm diameter x 60mm deep. Comes complete with 12V bulbs. Available in either black or chrome finish.



Part No.	Type	Each
<b>170503-C</b>	Chrome	<b>£81.02</b>
<b>170503</b>	Black	<b>£81.02</b>



Reproduction chrome plated Lucas ST51 split window 'D' light. Has two BA15s bulb holders and is supplied with 12V bulbs. One 5W bulb for tail light, one 21W for for brake light. The unit also has side window for number plate illumination.

**170501-S**

**£87.44**



Replica of Lucas MT211 rear lamp. Fitted with BAY15D 23/8W small globe (stop/tail) bulb. Lamp body approximately 25mm diameter x 45mm long with number plate illuminating window. Suitable for number plate mounting. Spare bulb 131005 (p.173) also available. Length: Approx 81mm. Mounting bracket diameter: 65mm.

**170522**

**£19.15**



Replica of Lucas 477/1 rear lamp. Fitted with BAY15D 23/8W small globe (stop/tail) bulb. Lamp body approximately 60mm diameter (max) x 50mm long with number plate illuminating window. Suitable for number plate mounting. Spare bulb 131005 (p.173) also available. Overall length: 90mm. Mounting bracket diameter: 65mm.

**170523**

**£25.10**



Replica of Miller stop/tail lamp. Fitted with 2 x 10W 12V single pole/filament bulbs BA15s (spare/alternative bulbs available- p.167). As fitted originally to Vincent twins and some Velocette models, but also ideal for custom applications. Diameter: 70mm. Depth: 65mm.

**170524**

**£21.80**



Rubber bodied marker lamp that can be used as a discrete tail lamp. Body diameter 45mm, lens diameter 35mm. Overall length 91mm. Supplied with mounting bracket. E-marked. Requires 12V, 5W BA15s bulb (130403 - p.167).

**170515**

**£18.43**



Rubber bodied tail lamp. 56mm diameter with a slightly curved plastic lens. Requires 30mm diameter panel hole. Overall length 78mm. Requires 12V, 5W BA15s bulb (130403 - p.167). E-marked.

**170514**

**£23.58**



Rubber-mounted tail lamp. Black plastic base with red lens. Two holes for fixing screws. 62 x 62 x 46mm. E-marked. Requires 5W festoon bulb (131702 - p.181).

**170506**

**£6.54**

## REVERSING LAMPS

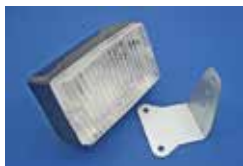

Reversing lamp that can either be surface mounted or attached with the bracket provided. 130 x 76 x 55mm. E-marked. Requires 12V, 21W bulb (130502 - p.167).

**173001**

**£7.64**



Reversing lamp mounted on an adjustable steel bracket. Black plastic body 125 x 80 x 75 (deep) mm. E-marked. Requires 12V, 21W bulb (130502 - p.167).

**173002**

**£16.71**

## REAR FOG LAMPS



Rear fog light suitable for surface mounting, supplied with adjustable pad to vary angle and mounting bolts. Requires BA15s bulb (130502 - p.167). 100mm x 93mm x 55mm (deep). E marked.

**172005**

**£17.40**



Rear fog lamp that can either be surface mounted or attached with the bracket provided. 130 x 76 x 55mm. E-marked. Requires 12V, 21W bulb (130502 - p.167).

**172001**

**£7.64**



Rear fog lamp mounted on an adjustable steel bracket. Black plastic body 125 x 80 x 75 (deep) mm. E-marked. Requires 12V, 21W bulb (130502 - p.167).

**172002**

**£16.71**

## NUMBER PLATE LAMPS



Black plastic number plate lamp. 83 x 30 x 35mm. Requires 12V, 5W festoon bulb (131702 - p.181). E-marked.

**170704**

**£6.25**



Plastic number plate lamp. Has plastic lens and rubber sealing gasket. 110 x 45 x 40mm. E-marked. Requires 2 x 12V BA9s 4W bulbs (130303 - p.165).

**170701**

**£17.03**



Polished stainless steel number plate lamp. Supplied with 2 x 12V BA9s bulbs. Has plastic lens and rubber sealing gasket. Supplied with 50cm leads with bullet connectors. E marked. This is the same part that is supplied to the Morgan Motor Co. (Approximate size 110mm x 40mm x 35mm deep).

**170702**

**£26.29**



Good quality replica of the Lucas L469 number plate lamp that was fitted to XK Jaguars, some Rover and other cars of the period. Has two BA9s 12V bulbs to illuminate the number plate and a BA15s 12V reversing light. Made from chrome plated brass. Supplied with leads having bullet connectors. Approx 165mm wide x 60mm deep x 45mm tall. Mounting bolts on 3" (76mm) centres.



Part No.	Type	Each
<b>170708</b>	Rear face mount	<b>£126.43</b>
<b>170708-B</b>	Underside mount	<b>£126.43</b>



LED bolt-style number plate lamps mounted on M8 threaded hollow bolt. Total length 32mm. Head dimensions 13mm diameter x 14mm. Maximum panel thickness 10mm. M8 Stud. Supplied with 40cm leads with Japanese bullet connectors.

**170650**

**£13.21**

contd...

## NUMBER PLATE LAMPS (contd)



Chrome-plated number plate lamp with glass bowl to protect bulb. Mounting centres 45mm (5mm bolts). Supplied with 40cm lead with bullet connector. Requires small globe BA15s bulb - p.167.

**170705**

**£14.39**



Chrome-plated number plate lamp. Mounting centres 40mm. Supplied with 50cm leads with bullet connectors. Requires BA9s bulb - p.165.

**170706**

**£9.25**

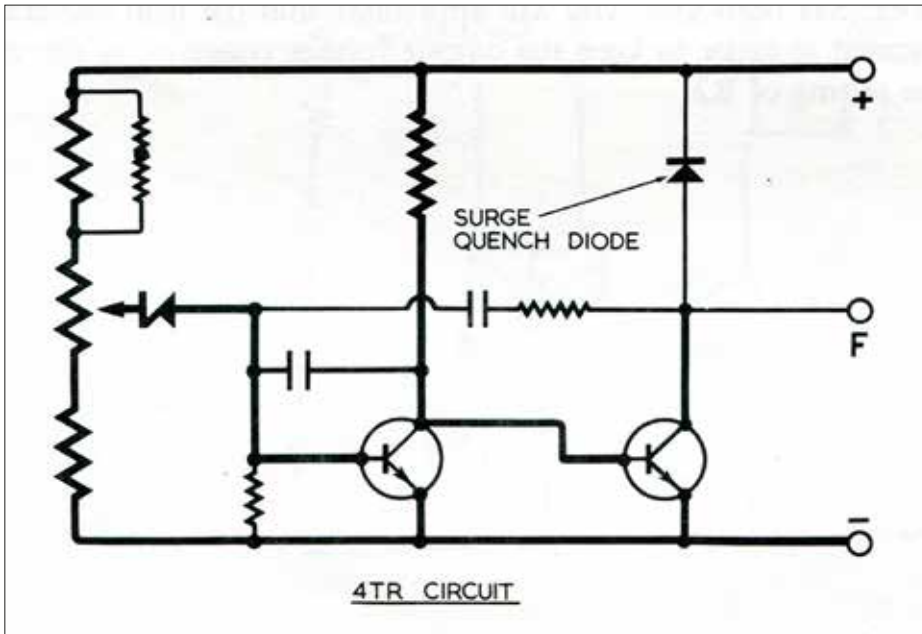

## INTERIOR LAMPS



Slimline circular LED interior lamp. Plastic lens on a white plastic base with on/off switch. Contains 117 white LEDs. 107mm diameter x 20mm deep. Operates on voltages between 10 & 30V. On 12V it is extremely bright (338 lumens!). Supplied with 3 mounting screws.

**176012**

**£38.91**



Low profile LED roof lamp. 12/24V, 36 bright white LEDs, surface mounting, in white plastic. For 24v application, connect the voltage converter (included with product). OD: 129mm. Height: 9mm.

**176013**

**£49.55**



Alfatronix PVPro-L reading light. Can be installed in the back of the seat in front. The light ray can be directed to the left or right as well as forward or backwards for discreet, yet maximum comfort for both the user and their neighbours. As it is situated behind the seat, there is no stream of light from the ceiling, so neither the driver nor other passengers are distracted. 12/24V. Requires 30mm panel hole.

**176014**

**£25.15**



Fluorescent tube interior lamp. Enamelled metal body with plastic lens and integral switch. 353 x 58 x 29 mm. Supplied with 12V, 8W fluorescent tube.

**176004**

**£30.40**



Replacement fluorescent tube 12V 8W bulb to fit the above strip light.

**176005**

**£7.06**

## MULTI-FUNCTION LAMPS



Rubbolite Model 64 "E" approved rear lamp. Stop/tail and direction indicator lamp with rubber housing. 202mm x 104mm x 50mm. Supplied with M6 mounting screws. Made in the UK. Requires BAY15d stop/tail bulb 131002 (p.173) and BA15s indicator bulb 130502 (p.167).

**64/01/11PP**

**£49.16**



Stop/tail and indicator lamp. Plastic base and plastic lens. 104 x 98 x 50mm. Supplied with fixing bolts and grommet. E-marked. Requires bulbs 130502 (p.167) & 131002 (p.173).

Part No.	Type	Each
<b>174001</b>	With number plate illumination	<b>£6.71</b>
<b>174002</b>	Without number plate illumination	<b>£6.56</b>



Stop/tail and indicator lamp. 180 x 58 x 50mm. Supplied with grommet. Requires one BA15s bulb (p.167) and one BAY15d bulb (p.173). Also available with a window to illuminate a number plate. (Lens and positions of the bulb holders can be reversed to effectively change the position of the number plate lamp). E-marked.

Part No.	Type	Each
<b>174003</b>	Without number plate illumination	<b>£11.19</b>
<b>174004</b>	With number plate illumination	<b>£11.19</b>



A pair of stop/tail and indicator lamps. One with number plate light and one without. The lamp can be altered to suit both right and left positions in either horizontal or vertical positions. 180 x 58 x 50mm. Supplied with grommet. Requires one BA15s bulb (p.167) and one BAY15d bulb (p.173) for each unit. E-marked.

**174005**

**£22.02**

## LAMP SPARES



Traditional bulb holder plug to connect into a range of vintage lamps. BA15d format (15mm diameter, level pins, two contacts). Wires into the plug are retained by small Allen key grub screws. Nickel plated brass construction. 7mm hole diameter for cable entry.

**132050**

**£15.12**



Bulb holders for Lucas L488 range of lights. Available as double or single contact versions.

Part No.	Type	Each
<b>132013</b>	Double contact (BAY15d)	<b>£7.40</b>
<b>132012</b>	Single contact (BA15s)	<b>£7.40</b>



Spare glass lenses for Lucas L488 lamps. Available in amber, clear or red.

Part No.	Colour	Each
<b>177004</b>	Amber	<b>£8.40</b>
<b>177005</b>	Clear	<b>£8.40</b>
<b>177006</b>	Red	<b>£8.40</b>



Lucas rubber body for L488 style lamps.

**178001**

**£4.17**



Chrome rim to suit both L488 and L594 style lamps (see over page for more L594 spares).

**178003**

**£2.71**

contd...



## LAMP SPARES (contd)



Bulb holders for Lucas L594 range of lights. Available as double or single contact versions.

Part No.	Type	Each
<b>132010</b>	Single contact (BA15s)	<b>£6.89</b>
<b>132011</b>	Double contact (BAY15d)	<b>£6.89</b>



Spare glass lenses for Lucas L594 lamps. Available in amber, clear or red.

Part No.	Colour	Each
<b>177001</b>	Amber	<b>£8.40</b>
<b>177002</b>	Clear	<b>£8.40</b>
<b>177003</b>	Red	<b>£8.40</b>

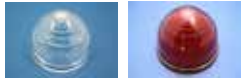

Lucas rubber body for L594 style lamps.

**178002**  
**£4.17**



Spare lens for Lucas L794 lamps. Supplied with gasket and fixing screws. E-marked.

Part No.	Colour	Each
<b>177012</b>	Amber	<b>£11.56</b>



Spare lens to fit the Lucas 1130 side/indicator lamp.

**177014**  
**£26.60**



Spare lenses for Lucas L691 (single filament) & L692 (double filament) lamps. Supplied with replacement screws and gasket.

Part No.	Colour	Each
<b>177007</b>	Amber	<b>£10.98</b>
<b>177008</b>	Clear	<b>£10.98</b>
<b>177009</b>	Red	<b>£10.98</b>



Replacement glass lens for Lucas ST38 lamps.

**170521**  
**£13.87**



Replacement lens for Lucas L549 rear lamp.

**177011**  
**£9.25**



Replacement rubber gasket for Lucas L549 rear lamp. Goes between base and vehicle.

**178004**  
**£3.96**



Replacement rubber gasket for Lucas L549 rear lamp. Goes between lens and base.

**178005**  
**£4.31**



Spare clear lens for Lucas L516 lamps, manufactured in plastic, but is otherwise identical to original glass lens. Diameter- 28mm. Height- 16mm.

**177013**  
**£5.29**

## REFLECTORS



Circular reflector (38mm diameter) with 52mm diameter chrome ring. Has rubber base and supplied with mounting screw and flat washer. Made in England to BS2515.

**175007**

**£12.76**



Lucas red reflector. Diameter of reflective part 55mm. Overall diameter of unit 70mm. Chrome rim holds reflector to the rubber base, which is shaped to fit the slight curvature of the vehicle wing. Unit fixes to vehicle with self tapping screw. E-marked.

**175005**

**£13.05**



Red reflector with chrome plated metal surround. Reflective area 70 x 34mm. 5mm fixing holes on 80mm centres. Overall size 88 x 40mm. E-marked.

**175006**

**£11.19**



Red 60mm diameter reflector with fixing hole.

**175002**

**£0.95**



Red 83mm diameter reflector with fixing hole.

**175003**

**£1.43**



Red 90 x 40mm reflector with two fixing holes.

**175004**

**£1.70**



Red triangular reflector with two fixing holes.

**175001**

**£1.83**

## DASH BOARD WARNING LAMPS



Large warning lamp. Needs 9mm BA9s bulb (130302 - p.165) and 17mm panel hole. 6.3mm blade terminals. Please note these lamps will only take the straight shaped bulbs and will not work with the 'normal' bulb shaped ones.



Part No.	Colour	Each
<b>090109-A</b>	Amber	<b>£5.39</b>
<b>090109-G</b>	Green	<b>£5.39</b>
<b>090109-R</b>	Red	<b>£5.39</b>
<b>090109-U</b>	Blue	<b>£5.39</b>



LED warning lamp. Push fit into 8.2mm hole. Supplied with 300mm leads. Polarity sensitive. 12V.

Part No.	Colour	Each
<b>090113-A</b>	Amber	<b>£4.23</b>
<b>090113-G</b>	Green	<b>£4.23</b>
<b>090113-R</b>	Red	<b>£4.23</b>
<b>090113-RF</b>	Red (Flashing)	<b>£4.23</b>



LED warning lamp with nickel-plated surround. Fits into 8mm panel hole. **Works on both 12V and 24V.** Connection via solder tags. Max panel thickness 6mm.



Part No.	Colour	Each
<b>090118-R</b>	Red	<b>£4.86</b>
<b>090118-G</b>	Green	<b>£4.86</b>
<b>090118-A</b>	Amber	<b>£4.86</b>
<b>090118-U</b>	Blue	<b>£4.86</b>

contd...

## DASH BOARD WARNING LAMPS (contd)



Older style warning lamp with turned aluminium bezel. Bezel diameter 22mm. Requires 17.5mm panel hole. Maximum panel thickness 10mm. Requires BA9s bulb, 2.2W (not supplied - see p.165). 2 x screw terminals.



Part No.	Colour	Function	Each
<b>090117-A</b>	Amber	General Purpose	<b>£5.02</b>
<b>090117-G</b>	Green	General Purpose	<b>£5.02</b>
<b>090117-U</b>	Blue	General Purpose	<b>£5.02</b>
<b>090117-R</b>	Red	General Purpose	<b>£5.02</b>
<b>090117-CH</b>	Red	Battery Charge	<b>£5.40</b>
<b>090117-BR</b>	Red	Brake	<b>£5.40</b>
<b>090117-Fan</b>	Amber	Fan	<b>£5.40</b>
<b>090117-FGA</b>	Amber	Fog Light	<b>£5.40</b>
<b>090117-FGR</b>	Red	Fog Light	<b>£5.40</b>
<b>090117-H</b>	Red	Hazard	<b>£5.40</b>
<b>090117-HL</b>	Blue	Headlight	<b>£5.40</b>
<b>090117-IN1</b>	Green	Indicators (one direction)	<b>£5.40</b>
<b>090117-IN2</b>	Green	Indicators (two directions)	<b>£5.40</b>
<b>090117-LI</b>	Blue	Lights on	<b>£5.40</b>
<b>090117-OP</b>	Amber	Oil Pressure	<b>£5.40</b>



Classic-style Lucas warning lamps. 6.3mm blade terminals. Needs 13mm panel hole. BA7s bulbs are included.



Part No.	Colour	Lucas Part No.	Each
<b>090101-A</b>	Amber	SPB357	<b>£3.52</b>
<b>090101-G</b>	Green	SPB355	<b>£3.52</b>
<b>090101-R</b>	Red	SPB354	<b>£3.52</b>
<b>090101-U</b>	Blue	SPB356	<b>£3.52</b>



Lucas jewel-type warning lamps. 6.3mm blade terminals. Needs 13mm panel hole. Require a BA7s bulb (sold separately - p.165).



Part No.	Colour	Lucas Part No.	Each
<b>090119-A</b>	Amber	WW10453 / 38190	<b>£6.08</b>
<b>090119-G</b>	Green	WW10452 / 38191	<b>£6.08</b>
<b>090119-R</b>	Red	WW10451 / 38189	<b>£6.08</b>
<b>090119-U</b>	Blue	WW10454 / 38192	<b>£6.08</b>

## JUNCTION BOXES



4-way circular junction box. 4 screw terminals. 57mm diameter. Lid with retaining screw.

**090601**  
**£4.64**



An 8-way junction box with rubber body and a clear plastic cover. The body has four waterproof cable glands. W110 x D90 x H41mm. Supplied with mounting bolts.

**090501**  
**£18.06**



Junction box with black phenolic body and lid. Waterproof cable glands at each end. Lid secured by knurled nut and sealed by a waterproof gasket. Can accept cables up to 6mm<sup>2</sup>. Screw connections. W125 X D73 x H25mm.

Part No.	Type	Each
<b>090401</b>	6-way	<b>£16.42</b>
<b>090402</b>	12-way	<b>£21.01</b>



Small splash-proof plastic junction box suitable for taking lengths of connector block if required. Comes complete with 2 cable retaining clamps and screws to secure the lid (which also has a clip to keep it shut). Also has flanged brackets with holes for fixing. Approximate dimensions excluding fixing lugs, 75mm x 50mm x 27mm.

**090404**  
**£4.40**

## CIGAR LIGHTERS & ACCESSORIES



Non-illuminated cigar lighter. Requires 25mm panel hole. Suitable for dashboard mounting. Connection via 2 x 6.3mm blade terminals.

**090204**

**£12.94**



Cigarette lighter plug with green LED. Fits most cigar lighter sockets with red adapter extended. With red adapter retracted, fits standard DIN socket. Has an internal fuse of 8A.

**090202**

**£5.75**



Cigar lighter plug with integral replaceable fuse (supplied) and green LED to indicate power is on. Ergonomically designed with an easy grip body.

**090207**

**£4.21**



Cigar lighter plug extension lead. Coiled cable, 2.45m working length with standard lighter plug and socket. Rated at 5A at 12V DC continuous.

**090209**

**£11.19**



Cigar lighter socket only. Non-illuminated. Requires 28mm panel hole. Max panel thickness 8mm. Supplied with plastic dust cap. Max 20A.

**090206**

**£6.70**



Cigar lighter socket. Suitable for making flying lead cigar lighter sockets. Has internal solder connections and cable strain relief.

**090210**

**£2.91**



Cigar lighter plug supplying a double socket via flexible cable. 10A max.

**090208**

**£14.04**



12/24V cigar socket doubler with twin USB. Power or charge most USB devices whilst in a car, van or truck. Compatible with most iPhones & iPads, mobile phones & bluetooth devices, etc. 2 x Cigar Sockets, 1 x 1 Amp USB, 1 x 2.1 Amp USB, 500mm lead.

**090213**

**£17.69**

## USB SOCKETS & ADAPTERS



USB 2 port adapter that fits into standard cigar lighter sockets. Useful for charging phones and tablets etc.

**090212**

**£9.09**



12V double USB sockets. 12V input, 5V output. 37mm diameter. Require 29mm panel hole. Max panel thickness 29mm. Supplied with nut and rubber cover. Connection via 2 x 6.3mm blade.

Suitable mounting panel 090218.



Part No.	Sockets	Power Indication	Each
<b>090211</b>	2.1A and 1A	Blue LED	<b>£13.66</b>
<b>090217</b>	2 x 1A	Blue panel	<b>£10.48</b>
<b>090218</b>	-	-	<b>£2.21</b>



UK manufactured (Alfatronix) high quality double USB socket, suitable for use on 12V or 24V systems. Advanced electronics detect the charge status of the device and alters the charging process accordingly, ensuring that the device connected will always be charged as fully as time will allow. Output current 3A (max 1.5A per socket). 6.3mm blade terminal connections. Supplied with fixing nut, washer and two female blade terminals. Requires 30mm diameter panel hole. Blue LED power indicator. 3 year guarantee.

**090214**

**£25.15**



contd...

## USB SOCKETS & ADAPTERS (contd)



Made in the UK (Alfatronix) high-quality single USB plug mounted on a card, suitable for use on 12V or 24V systems. This plug can be secured under or behind the dashboard using the clamps provided, avoiding drilling holes in the dashboard, etc. The advanced electronics detects the charging status of the device and modifies the charging process accordingly, ensuring that the connected device will always be charged as fully as time permits. Output current 2.1A. Blade terminal connections 6.3 mm. Blue Power LED. 3 years warranty.

**090215**

**£21.17**



12/24V cigar socket doubler with twin USB. Power or charge most USB devices whilst in a car, van or truck. Compatible with most iPhones & iPads, mobile phones & bluetooth devices, etc. 2 x Cigar Sockets, 1 x 1 Amp USB, 1 x 2.1 Amp USB, 500mm lead.

**090213**

**£17.69**

## DIN SOCKETS & PLUGS



DIN plug. To fit all of DIN sockets. 16A max.

**090304**

**£5.29**



DIN panel socket. Requires 16mm hole. Maximum panel thickness 9mm. 16A maximum.

**090301**

**£6.55**



DIN socket with spring loaded cap. Requires 18mm hole. Maximum panel thickness 15mm. 2 x 6.3mm blade terminals. 16A maximum.

**090305**

**£8.68**



DIN surface mount socket. Supplied with fixing screws. 16A maximum.

**090302**

**£9.45**



Triple DIN socket. 3 sockets mounted on a panel. Hole required 70 x 20mm. Supplied with fixing screws. 16A maximum.

**090303**

**£20.78**

## DIODES



Universal in-line diode. 10 amp, 50 volt dc, with male (-) and female (+) 6.3mm blade terminals.

**082101**

**£3.34**

## GAUGES & SOCKET PANELS



Digital voltmeter. Works between 6V & 33V. Requires 29mm panel hole or will fit panel 090218. 2 x 6.3mm blade terminals. Reads to nearest 0.1 V.

**090230**

**£15.66**



Digital ammeter. Works between 12V- 24V. Requires 29mm panel hole or will fit panel 090218. 2 x 6.3mm blade terminals (power required) and 2 tails. Reads to nearest 0.1A.

**090231**

**£25.38**



Plastic panels for mounting USB sockets and gauges. Suitable for double USB sockets 090211 and 090217. Also voltmeter 090230 and ammeter 090231.

Part No.	Type	Each
<b>090218</b>	Single	<b>£2.21</b>
<b>090219</b>	Double	<b>£3.70</b>



## DASHBOARD BUZZERS



Dashboard buzzer. 12V loud and urgent tone. Suitable for use as an indicator warning buzzer, etc. 2 x 6.3mm blade terminals.

**140403**  
**£9.31**



Dashboard buzzer. 12V, 2 tone, 72dB(A). More of a warble than a buzz. Single hole fixing. 2 x 6.3mm blade terminals.

**140401**  
**£12.98**



Lights on warning buzzer. For use on 12V negative earth systems providing a two tone warning alarm if the drivers door is opened when the vehicle lights are on and the ignition is off. 3 x 6.3mm blade terminals. 2 tone, 72dB(A). Supplied with wiring diagram.

**140402**  
**£12.64**



Back-up alarm with 105 dB(A) intermittent sound. 12 & 24V options. Made from black plastic with metal fixing bracket. 55mm diameter. CE approved.

Part No.	Voltage	Each
<b>140404</b>	12V	<b>£18.45</b>
<b>140405</b>	24V	<b>£18.45</b>

## DASHBOARD GAUGE VOLTAGE STABILIZERS



Dashboard gauge voltage stabilizer. Output voltage stabilized to 10V +/- 0.4V. A single stabilizer will service two gauges. Fitted with two dual blade connectors: Male 6.35mm dual blade connectors marked 'B' should be connected to switched ignition voltage. Female 6.35mm dual blade connectors marked 'I' is the stabilized 10V output. The case (via the fixing bracket) must be bolted to the chassis/ground.



Part No.	Type	Each
<b>090701</b>	Negative Earth	<b>£17.48</b>
<b>090702</b>	Positive Earth	<b>£7.48</b>

## VEHICLE HORNS



Black 6V horn, 92mm diameter. 90mm long mounting bracket, with a single 8mm mounting hole. 430Hz, 105db with 2 x 6.3mm Lucar connections.

**200108**  
**£12.56**



Chrome disc horn. 100mm diameter. 90mm long mounting bracket, with a single 8mm mounting hole. 430Hz, 105db with 2 x 6.3mm Lucar connections.

Part No.	Voltage	Each
<b>200109</b>	6V	<b>£13.21</b>
<b>200110</b>	12V	<b>£13.21</b>



Basic disc horn, diaphragm type. Supplied with bracket. Connection via 2 x 6.3mm blade terminals. 335Hz, 100mm OD, 12V.

**200101**  
**£11.50**



Compact disc horn. 77mm OD. Diaphragm type with black painted steel body. Supplied with bracket. Connection via 2 x 6.3mm blade terminals. 103dB(A), 335 or 420Hz, 12V.

Part No.	Type	Each
<b>200102</b>	Low tone (335Hz)	<b>£12.95</b>
<b>200103</b>	High tone (420Hz)	<b>£12.95</b>



Twin 12V Fiamm electric air horns (405Hz & 500Hz). Supplied as a pair of horns with relay, mounting kit & instructions. Very loud! (110dBA).

**200104**  
**£21.46 / pair**



Twin Marco air horns and compressor. Supplied with relay, tube and mounting brackets. Horn lengths 150 and 190mm. 700-850Hz, 12V.

**200105**  
**£31.34**

## FUEL PUMPS



Lucas FDB790 universal fuel pump, suitable for carburettor fuel systems having 1, 2 or 3 carburettors. Extremely quiet and reliable. Zinc plated steel cased. 0.17 - 0.31 Bar (2.5-4.5 PSI). 90-130 litres/hour flow rate. 5A current draw. 172mm long x 54mm diameter. 1/8" NPT threaded outlets. Includes filter, mounting bracket, 8mm OD fuel pipe unions, 2 x 100mm lengths of fuel hose, 4 x hose clips. 2 Year warranty.

**LUCAS FDB790**

**£59.91**



Standard SU fuel pumps (AUA25/26) for bulk head mounting. Available in 12V or 6V. Dual Polarity (can be fitted to both negative and positive earth vehicles). Capable of lifting fuel a height of 42" from fuel tank. Fitted with points as per original (spare points available). 1/4 BSP fittings.



Part No.	Type	Each
<b>AUA25</b>	12V fuel pump	<b>£164.39</b>
<b>AUA26</b>	6V fuel pump	<b>£164.39</b>
<b>AUB6106</b>	Spare points (6V & 12V)	<b>£19.08</b>

## FUEL SOLENOID VALVES



Anti-theft 12V solenoid valve for petrol and diesel. Cuts off fuel when not energised. Bore of 5.5mm. Pressure 0- 3 bar, flow coefficient of 0.28. 8mm OD. Current draw 0.44A. Protected to IP65. Large bore versions (250102 & 250103) have bore of 7.0mm, flow coefficient of 0.60 and OD 11mm, current draw 1.06A. 24V version of the large bore type also available.



Part No.	Voltage	Bore (mm)	Each
<b>250101</b>	12V	5.5	<b>£63.45</b>
<b>250102</b>	12V	7.0	<b>£93.72</b>
<b>250103</b>	24V	7.0	<b>£113.52</b>

## WIPER MOTORS



Universal wiper motor with an on/off switch on rear of casing. The mounting shaft has an M10 thread along its length and allows the wiper to be fitted to frames up to 84mm thick. The mounting shaft and the co-axial driving shaft (6mm diameter) can be cut down to suit any frame up to this thickness. Approximate case dimensions 75mm wide x 50mm tall x 75mm deep. Available with either an 85° or 110° travelling arc. 12V.

Part No.	Type	Each
<b>190101</b>	110°	<b>£99.75</b>
<b>190102</b>	85°	<b>£99.75</b>

## WASHER PUMPS, BAGS & BOTTLES



12V vane-type washer pump with universal fixing bracket. Connection via 2 x 6.3mm blade terminals.

**190201**

**£15.24**



12V vane-type washer pump with metal fixing bracket. Genuine Lucas WSB 100. These pumps are polarity sensitive and will not work if connected incorrectly.

**WSB100**

**£13.87**



12V washer pump and bag. Plastic bag (incorporating pump) hangs on metal bracket provided. Supplied with all necessary fittings including push button switch, pipe and nozzles. Approx 2 litre capacity. (21 x 28cm).

**190202**

**£25.17**

contd...

## WASHER PUMPS, BAGS & BOTTLES (contd)



Washer pump and bottle kit. Rigid plastic bottle incorporating pump with fixing bracket. Approx 1.2 litre capacity. Approximate dimensions: 120 wide x 90 deep x 170 tall (mm). Supplied with all parts needed inc. plastic pipe, water jets, push button switch, cable etc. Available in 12V or 24V versions.

Part No.	Voltage	Each
<b>190203</b>	12V	<b>£23.12</b>
<b>190205</b>	24V	<b>£23.12</b>



4mm bore clear pvc tubing suitable for use with washer systems. Internal diameter: 4mm. Temp: -15° - +60°C. Outside diameter: 6mm.

<b>290001</b>
<b>£1.89 / m</b>
<b>£41.32 / 50m</b>



Newly manufactured 12V Lucas 2SJ washer bottle and pump (C17004). Has glass bottle with screw on cap with built in washer pump and separate mounting bracket. Made by Lucas in England.

<b>190220</b>
<b>£195.00</b>



Newly manufactured 12V Lucas 5SJ washer bottle and pump (C25438). Supplied with mounting bracket and pump fitted to the lid. Made in the England by Lucas.

<b>190221</b>
<b>£130.00</b>



Newly manufactured 12V Lucas TKC2279 washer bottle and pump. Suitable for many E type and Mk2 Jaguars etc. Supplied with mounting bracket and pump fitted to the lid. Made in the England by Lucas.

<b>190222</b>
<b>£65.64</b>

## COOLING FANS



A Range of 4 Spal radiator fans of different diameters (9", 10", 11" & 12") and air flow rates. All fans in this section suck the air - ie. are for mounting on the rear of a radiator. Spal fans are manufactured in Italy, have motors that are sealed to IP58 and have low noise blades. Overall depth 52mm.

Part No.	Size (in)	Max Flow (m³/hr)	Current (A)	Each
<b>190301</b>	9	1060	6.7	<b>£86.19</b>
<b>190302</b>	10	1360	8.7	<b>£87.82</b>
<b>190303</b>	11	1390	7.8	<b>£85.86</b>
<b>190304</b>	12	1540	6.7	<b>£90.10</b>

## DYNAMOS



Lucas C40 and C40L dynamos that have been **fully reconditioned by a UK specialist**. Will have been stripped down, checked over and rebuilt using new parts where necessary, and has a one year guarantee. Supplied without fan and pulley (although these are available separately if required - p.223) and polarized for negative earth. 15mm diameter shaft. No exchange dynamo necessary.



Part No.	Type	Each
<b>160703</b>	C40	<b>£131.25</b>
<b>160710</b>	C40L	<b>£119.82</b>



Replica Lucas C40 dynamo. A well engineered copy. Has 15mm diameter shaft, and comes with key, nut and spring washer. Has two terminals. 9.5mm male blade (D+) and 6.3mm male blade (F). Requires pulley and cooling fan - p.223.

<b>160501</b>
<b>£85.51</b>



Replica Lucas C40T dynamo. Essentially a C40 dynamo with a tachometer drive bolted to the rear casting. This is a well engineered copy. Has a 15mm diameter shaft, and comes with fan, key, nut and spring washer. Has two terminals. 9.5mm male blade (D+) and 6.3mm male blade (F). Requires pulley - p.223.

<b>160502</b>
<b>£87.99</b>

contd...

## DYNAMOS (contd)



Replica Lucas C40A dynamo. Is essentially a sealed C40 dynamo, with no ventilation openings in the castings. Primarily used on agricultural vehicles, or in dirty conditions. Due to its lack of ventilation, current output needs to be limited, otherwise it will overheat. The easiest way to do this, is with an 11A current limiting regulator 160205 - p.224. This is a well engineered copy. Has a 15mm diameter shaft, and comes with key, nut and spring washer. Has two terminals. 9.5mm male blade (D+) and 6.3mm male blade (F). Requires fan and pulley.

**160503**

**£77.16**



Replica Bosch dynamo. A quality reproduction of Bosch dynamo 0101 302 067. It also replaces 0101 302 068, 075 & 076 units. It has a through shaft, being 15mm diameter at each end. Both have keyways, and keys are supplied. Approximate body diameter 104mm, body length 175mm, overall length, 260mm. Two terminals (M5 studs) D & F. Output, 30A @ 12V. Requires pulley and cooling fan. (Can be used with 12V Bosch regulator 160404 - p.225).

**160504**

**£105.60**

## DYNAMO BRUSHES



Replacement brushes for Lucas C39 and C40 dynamos.

Part No.	To Suit Dynamo	Size (mm)	Pair
<b>180101</b>	C40	5.5 x 19.05 x 18.2	<b>£2.69</b>
<b>180102</b>	C39	6.35 x 19.05 x 15.9	<b>£2.65</b>

## ALTERNATOR & DYNAMO FANS



Fans suitable for use on Lucas style alternators. Made from plated steel. Two diameters available: 134mm (suitable for A127 type alternators) - 17mm bore 119mm (suitable for ACR type alternators) - 15mm bore

Part No.	Diameter (mm)	Bore (mm)	Each
<b>160604</b>	134	17	<b>£8.38</b>
<b>160608</b>	119	15	<b>£6.92</b>



Fan suitable for use on Lucas style dynamos and 'Dynator' alternators. Two styles available, both having 15mm bore with keyway slot.

Part No.	Diameter (mm)	Bore (mm)	Each
<b>160603</b>	123	15	<b>£5.76</b>
<b>160609</b>	125	15	<b>£8.18</b>

## PULLEYS

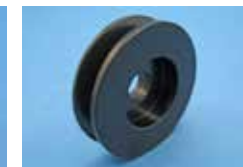

We sell a large range of pulleys of various types, sizes and materials. Because of the nature of their diversity, it is not possible to list them all in the catalogue. Please see our website: [autoelectricsupplies.co.uk](http://autoelectricsupplies.co.uk) for our most up to date range.

## DYNAMO REGULATORS



Reproduction Lucas RB106 voltage regulator. 12V, 22A. Screw terminals.

**160201**

**£43.55**



Reproduction Lucas RB106 voltage regulator. 12V, 22A. Blade terminals.

**160202**

**£43.55**



Lucas RF95 regulator. This is a good replica version as original Lucas items have not been available for years. Complete with fuses and wiring diagram. Available in 12V and 6V versions.

Part No.	Voltage	Each
<b>160211</b>	12V	<b>£188.71</b>
<b>160212</b>	6V	<b>£176.14</b>



A range of 12V reproduction Lucas RB340 dynamo regulators having different outputs. The 11A version is mainly used on agricultural equipment, tractors, etc.

Part No.	Output (A)	Replaces	Each
<b>160203</b>	25	RB340, NCB131, NCB133, etc	<b>£28.74</b>
<b>160204</b>	22	RB340, NCB130, etc	<b>£28.74</b>
<b>160205</b>	11	RB340, NCB134, NCB136, etc	<b>£28.90</b>



12V, 11A. dynamo regulator. Replaces Lucas RB108, NCB118, etc.

**160207**

**£33.77**



12V, 11A. Replaces Lucas RB108, NCB118, etc. This unit uses bullet connectors which are available separately (031006- p.53). The bullets are sealed using a waterproof gasket preventing moisture ingress.

**160208**

**£38.00**



12V, 11A. dynamo regulator. Replaces Lucas RB108, NCB118, etc.

**160206**

**£38.00**

## ALTERNATOR REGULATORS



Alternator regulator. 4 x 6.3mm blade terminals. Replaces: Lucas NCB148- 4TR, 37527, 37550, 37586, 37644, 37694.

**160210**

**£37.76**



Alternator regulator, NCB144- 4TR. 3 x 6.3mm blade terminals. Replaces: Lucas NCB144- 4TR, 37423, 37449, 37538, 37548, 37551, 37585, 37589, 37641, 37643, 37693, 37700.

**160209**

**£37.76**



Voltage regulator to fit 12V Lucas type A127 alternators.

**160214**

**£25.85**

## BOSCH-TYPE REGULATOR



12V 30A Bosch-type voltage regulator. This is a well made replacement part, manufactured in United States. Replaces Bosch parts 0190.300: 036, 037, 049, 067, 070, 087, 0190.309: 002, 009, 019, 025, 030, 036, 038, 0190.350: 005, 038, 039, 054, 059, 069, 079.

**160404**

**£77.82**



## BOSCH REGULATORS



A range of 12V Bosch voltage regulators. Available for different current ratings. Work by regulating to earth. Not suitable for use with Lucas dynamos. (Manufactured in Germany). These generator regulators are electronic regulators within a historic housing. The electronics make it possible to reliably control voltage and current free of wear. The on board electrical system is thereby protected from over voltage, and the generator is not overloaded. The battery is also kept from overheating. The regulator housing is sealed against dust and pressure waterproof (according to IP69K) and can therefore also be mounted at an exposed location.

Part No.	Output (A)	Replaces	Each
<b>160405</b>	11	0190.215.027, etc	<b>£123.24</b>
<b>160409</b>	16	0190.213.009, etc	<b>£130.96</b>
<b>160406</b>	20	0190.213.033, etc	<b>£117.54</b>
<b>160407</b>	25	0190.215.034, etc	<b>£124.38</b>
<b>160408</b>	30	0190.350.068	<b>£142.63</b>

## 12V DYNASTART



12V Dynastart. This is a good quality unit manufactured in Italy. Produces 11A. 0.9kW starting power. Clockwise rotation. 106mm diameter x 237mm long. Replaces Bosch 0010.300.001, 0010.300.003, 0010.300.101, 0010.350.005, 0010.350.102. Suitable regulator 160405.

**260106**

**£237.04**



## HI TORQUE STARTER MOTORS



High torque starter motors are modern gear reduction units adapted to fit older vehicle applications. We offer units supplied by WOSPerformance, who are a specialist UK manufacturer, having over 40 years experience in the automotive manufacturing sector. The main advantages over the original starter are weight and space saving, improved performance and a reduced strain on the vehicle's battery:

- Approximately twice as powerful as the original. Consequently, they run faster and start the engine more easily.
- They draw about half the current of an original starter putting less strain on the battery and electrical system of the vehicle.
- Weight can be reduced up to 50% from conventional starters.
- The starters are usually smaller and easier to fit than the standard starter motors.
- Increased reliability due to use of modern materials and components.

We offer a wide range of high torque units, all of which are direct bolt-on replacements requiring no modification to wiring or fitting. We can also manufacture bespoke units- quickly and at a reasonable cost, and can supply various spare parts. Supplied with wiring diagram and fitting instructions and come with a 3 year warranty. FREE carriage to UK mainland.



## 'DYNATOR' ALTERNATORS



Manufactured in the UK by WOSPerformance to BSI ISO9002, these alternators have been engineered to look the same as the original dynamos that they are replacing. The advantage is that your vehicle will retain its original look whilst having a more powerful and reliable charging system. Other advantages over the original dynamo are:

- Generate approximately twice the output
- Much simplified wiring as units have built-in voltage regulators
- Much lighter- approx 60% the weight of the original unit
- Increased reliability due to use of modern materials and components

The range of these lightweight dynamo replacements includes C39, C40, C42 and C45 Lucas types, along with replacements for classic Lancias, Ferraris and many others. Less common & bespoke units are also available. Dynators are available for both negative and positive earth applications and can also be manufactured for 6V systems. Supplied fitted with cooling fan and 63mm diameter pulley suitable for 10mm wide ('Z' section) belt. If a different pulley is required, then please enquire. 3 year guarantee. FREE carriage to UK mainland.

## TOWING ACCESSORIES - PLUGS



7-pin 12N plastic plug to fit 12N sockets (metal or plastic). 12N plugs and sockets are the normal type for trailer lights etc. Terminals connect as follows: 1. LH indicator lamp, 2. Rear fog lamp, 3. Earth, 4. RH indicator lamp, 5. RH tail/number plate lamp, 6. Brake lights, 7. LH tail/number plate lamp.

**230102**  
**£3.44**



7-pin 12N metal plug to fit 12N sockets (metal or plastic). 12N plugs and sockets are the normal type for trailer lights etc. Terminals connect as follows: 1. LH indicator lamp, 2. Rear fog lamp, 3. Earth, 4. RH indicator lamp, 5. RH tail/number plate lamp, 6. Brake lights, 7. LH tail/number plate lamp.

**230101**  
**£4.63**



7-pin 12S plastic plug to fit 12S socket 230106 - p.231. 12S plugs and sockets are for supplementary applications such as caravan power, etc.

**230105**  
**£3.23**



13-pin plastic trailer plug.

**230107**  
**£8.12**

## TOWING ACCESSORIES - SOCKETS



7-pin 12N plastic socket with spring loaded cap, that covers connectors once trailer plug has been removed. Cap has rubber gasket incorporated to help seal out moisture. 12N plugs and sockets are the normal type for trailer lights etc. Socket disassembles to aid wiring with pin numbers shown on cap gasket. Use gasket 230303 to seal rear face of socket to vehicle (needs to be purchased separately - p.229).

**230104**  
**£4.31**



7-pin 12N metal socket with spring loaded cap, that covers connectors once trailer plug has been removed. 12N plugs and sockets are the normal type for trailer lights etc. Socket disassembles to aid wiring with pin numbers shown on cap. Use gasket 230303 to seal rear face of socket to vehicle (needs to be purchased separately - see below).

**230103**  
**£5.10**



7-pin 12S plastic socket with spring loaded cap, that covers connectors once trailer plug has been removed. Cap has rubber gasket incorporated to help seal out moisture. 12S plugs and sockets are for supplementary applications such as caravan power etc. Socket disassembles to aid wiring with pin numbers shown on cap gasket. Use gasket 230303 to seal rear face of socket to vehicle (needs to be purchased separately - see below).

**230106**  
**£4.63**



Rubber socket gasket suitable for 7-pin sockets 230103, 230104 and 230106.

**230303**  
**£1.25**

## TOWING ACCESSORIES - SOCKET ADAPTERS



12V 13-pin to 7-pin trailer socket adapter.

**230502**  
**£7.93**



12V 7-pin to 13-pin trailer socket adapter.

**230503**  
**£7.93**

## TOWING ACCESSORIES - EXTENSION LEAD



Trailer extension lead. 6m long lead with a 12N plug on one end and a 12N socket on the other. Useful for elongating trailer board leads, etc.

**230501**

**£30.52**

## TOWING ACCESSORIES - PRE-WIRED SOCKETS



7-pin plastic socket (12N) on mounting plate with 1.5 metres of cable.

**230201**

**£11.11**



7-pin plastic socket (12N) and 7-pin plastic socket (12S) mounted on double plate with cable.

**230203**

**£20.95**



7-pin plastic socket (12S) on mounting plate with 2 metres of cable.

**230202**

**£11.89**

## TOWING ACCESSORIES - TRAILER LIGHTING SET



Pair of magnetic multi-function lamps with attached triangular reflectors. Prewired with 7.5m of cable to a standard trailer plug. Supplied with bulbs. Very useful and adaptable set. Plug-in and go. E-marked.

**174006**

**£65.85**

## TOWING ACCESSORIES - MOUNTING PLATES



Single socket side mounting plate.

**230301**

**£2.39**



Double socket side mounting plate.

**230302**

**£3.90**

## TOWING ACCESSORIES - CHARGING RELAYS



Durite version of Lucas SRB630 split charge relay. This relay enables the connection of a second battery and/or fridge, and can be triggered by the ignition supply or the alternator warning lamp. Connections as per Lucas SRB630.

**140236**

**£38.40**



Lucas SRB630 60A split charge relay. Enables connection of second battery and/or fridge. Can be triggered from ignition supply or alternator warning light terminal. (Replaces Lucas 33441).

**140235**

**£26.03**



Voltage sensitive battery isolator relay. 12V, 80A. Useful for disconnecting non essential equipment to prevent the main battery from becoming fully discharged. Relay makes at 12.8V and breaks at 11.0V. 68 x 54 x 68mm.

**140292**

**£50.85**



Voltage sensitive relays. 12 or 24V 140A with red LED indicator. Allows split charging of a second battery, without discharging the primary/start battery. 2 x M6 stud connections. 68 x 54 x 68mm.

Part No.	Voltage	Makes / Breaks	Each
<b>140290</b>	12V	13.3V / 12.8V	<b>£32.36</b>
<b>140293</b>	24V	26.6V / 25.6V	<b>£32.36</b>

## TOWING ACCESSORIES - CHARGING RELAYS (contd)



12V 160A programmable voltage sensitive relay. Easily programmed by pressing an integral button, so that different make and break voltages can be set. Ideal for connecting a secondary battery to the primary battery when the voltage reaches the set value (Cut-in). Secondary battery will be disconnected when the voltage drops to the lower value (Cut-out). 9 voltage combinations available. Supplied with fixings and terminals.

**140295**

**£49.61**

## TOWING ACCESSORIES - TRAILER FLASHER RELAYS



12V indicator relay with an additional base connection (C2) to feed a dashboard warning light that illuminates when indicating with a trailer attached. This relay can be used to upgrade from relay 140112 (p.140), if the trailer warning facility is required. Will power up to 6 x 21W bulbs and an additional 2W warning lamp.

**140114**

**£16.51**



A small kit consisting of a buzzer and a monitoring module, that detects when trailer indicators are connected to a towing vehicle. The module monitors the current draw to the trailer and, if detected, sounds the buzzer. This gives the driver an audible warning that their trailer indicator lights are working and also reminds them that they are towing a trailer. The module connects between the rear lights of the vehicle and the towing socket, and the buzzer can be located near the driver as the kit has a 3.5 m long flying lead to facilitate this connection. Supplied with connection instructions.

**230404**

**£17.96**

### YOU MAY ALSO BE INTERESTED IN:

- Trailer Cable - p.16

## CRIMPING TOOLS - INSULATED TERMINALS



Economy tool for crimping the full range of **insulated terminals**. Also features a wire stripper and cable cutter.

**150201**

**£4.60**



Tool for crimping the full range of **insulated terminals and many non-insulated terminals**. Also features a wire stripper, cable cutter and cushion handles.

**150202**

**£7.49**



Heavy duty ratchet tool for crimping the full range of **insulated terminals**. This tool ensures the correct pressure is applied whilst crimping the terminal.

**150203**

**£37.33**

## CRIMPING TOOLS - NON-INSULATED TERMINALS



Economy tool for crimping many **non-insulated terminals**. Also features wire stripper and cable cutter.

**150204**

**£5.19**



Robust and heavy duty tool for crimping many **non-insulated terminals**. Folds tabs over and into wire and insulation. Also features wire stripper and cable cutter.

**150205**

**£15.91**



Ratchet tool for crimping many **non-insulated terminals**. This tool ensures the correct pressure is applied whilst crimping the terminal.

**150206**

**£42.46**

## CRIMPING TOOLS - FOR VARIOUS TERMINALS



Ratchet tool for crimping 6.3mm **flag terminals**. This tool ensures the correct pressure is applied whilst crimping the terminal. The terminal is held in the correct place by sliding it onto a tab within the jaws of the tool.

**150215**

**£65.86**



Heavy duty ratchet type crimping tool for crimping **Econoseal and Superseal** (both 1.5 & 2.8mm blade) terminals. This tool ensures that the correct pressure is applied whilst crimping the terminals.

**150211**

**£37.76**



Heavy duty ratchet type crimping tool for crimping **Junior Power Timer terminals** on cable up to 2mm<sup>2</sup>. This tool ensures that the correct pressure is applied whilst crimping the terminals.

**150212**

**£52.54**



Heavy duty ratchet type crimping tool for crimping **Junior Timer terminals** on cable up to 2mm<sup>2</sup>. This tool ensures that the correct pressure is applied whilst crimping the terminals.

**150216**

**£69.39**

## TOOLS FOR STANDARD BULLETS



Bullet crimping tool for **non-insulated bullets**. (031001, 031002, 031003 & 031004 - p.52).

**150207**

**£26.11**



For inserting soldered or crimped bullets into connectors. For use on 031101, 031102, 031104 & 031106 - p.54.

**150301**

**£17.42**

## CABLE STRIPPERS



Traditional manual cable stripper. Has adjustable stop setting. Can strip cables up to 6mm<sup>2</sup>.

**150403**

**£24.98**



Automatic cable strippers for cables between 0.5 and 3.0mm<sup>2</sup>.

**150402**

**£19.60**



Automatic cable strippers and cutters for cables between 0.5 and 6.0mm<sup>2</sup>. This tool is also suitable for crimping insulated and non-insulated terminals.

**150401**

**£17.71**

## TOOLS FOR HT TERMINALS



Professional tool for crimping ignition terminals onto HT cable. This tool has the advantage that during the crimping process, by using both sets of dies, the 'ears' on the terminal are forced into the insulation of the cable, preventing the terminal from coming off the cable, once crimped on.

**150602**

**£63.84**



Heavy duty budget ratchet tool for crimping HT terminals to HT cable. Also available as part of the HT Terminal Kit 160108 - p.74.

**150601**

**£40.77**



## CABLE CUTTERS



Pro's Kit diagonal cutting pliers or 'snips'. A good quality cable cutter. These are the tools we use every day at AES Ltd to prepare customer orders. We have not had a pair break yet! Capacity- Copper wire 1.6mm diameter. 125mm length, jaw length 13mm. 45° blade angle. PVC handle covers, medium carbon steel construction.

**150701**

**£3.87**



These cutters are perfect for creating a clean cut with cable without splaying the core conductors. This helps with attaching terminals and creating a professional finish. For cutting copper cables up to 70mm<sup>2</sup>. Tool length 235mm.

**150501**

**£24.07**



These lightweight cutters are perfect for creating a clean cut with cable without splaying the core conductors. This helps with attaching terminals and creating a professional finish. For cutting single copper cables up to 120mm<sup>2</sup> or twin core up to 50mm<sup>2</sup>. Tool length 420mm.

**150502**

**£71.52**

## TOOLS FOR BATTERY TERMINALS



Ratchet crimping tool for 4 sizes (10, 16, 25 & 40mm<sup>2</sup>) of open end and closed end battery cable terminals. The crimp must be complete before the tool ratchet can be released. A good quality compact tool.

**150209**

**£72.69**



Press tool for crimping open end and closed end battery cable terminals. Can crimp terminals up to 120mm<sup>2</sup>. The tool features a large sprung loaded punch and can crimp terminals using either a vice or hammer. Easy to use and very effective.

**150213**

**£22.19**



Heavy duty crimping tool for terminals from 10 to 120mm<sup>2</sup>. 580mm long and weighs approximately 3kg.

**150214**

**£105.85**

## MISCELLANEOUS TOOLS



This tool is suitable for applying neoprene expandable sleeves, by stretching them during application. (Neoprene sleeves - p.24).

**150102**

**£50.55**



A handy tool set for removing terminals from plastic housings. Each tool has six different extractors for releasing tabs on multiple connector terminals. Sold as a pair. The tubular tools suit the removal of round connectors, by sliding over the connector and bending the tabs flat. Will work with mini mate-n-lok, mate-n-lok and 3.5mm mate-n-lok range and many others. The flat strips suit the removal of male and female blade terminals, as they can be used to go down the side of the terminals to bend the tabs flat.

**150802**

**£24.60**



Tool to extract the terminals from Universal Mate-n-Lok plastic housings (having 2mm diameter terminals).

**150801**

**£36.16**

## SOLDERING



A good quality 240V, 40W soldering iron. Has high quality ceramic heating element and built-in LED light designed to aid working in low light levels and awkward, tight areas. Supplied with a 1m lead & 1mm tip. Alternative tips available (see below).

**220305**

**£12.35**



Part No.	Type	Each
<b>220307</b>	0.5mm pointed tip	<b>£2.38</b>
<b>220308</b>	1.0mm pointed tip	<b>£2.38</b>
<b>220309</b>	2.0mm chisel tip	<b>£2.38</b>
<b>220310</b>	3.0mm chisel tip	<b>£2.38</b>

## SOLDERING (contd)



A 12V 30W soldering iron supplied with an extra long 3m lead. Supplied with cigarette lighter plug. Long 3m lead. Ideal for outside work, automotive electrics. Alternative size tips can also be purchased (see previous page) and a suitable stand is also available - p.239.

**220306**

**£13.20**



Antex XS25. 25W, 240V soldering iron. British made to EN-60335-2-45. Supplied with 1.5m of cable and 3mm diameter replaceable tip (see 220303 - below). Supplied with small metal stand.

**220301**

**£35.46**



Antex MLXS25. 25W, 12V soldering iron. British made to EN-60335-2-45. Supplied with 4m of cable with crocodile clips to power from a car battery. 3mm diameter replaceable tip (220303 - below).

**220302**

**£38.23**



3mm diameter replacement tip for XS25 soldering iron (220301) and MLXS25 soldering iron (220302).

**220303**

**£6.27**



Antex GASCAT60 gas (butane) soldering iron. Supplied with 2.4mm diameter tip and safety cap with integral lighting flint. Spare tips available (see below).

**220401**

**£45.29**



Part No.	Diameter (mm)	Each
<b>220405</b>	1.0	<b>£11.98</b>
<b>220402</b>	2.4	<b>£11.98</b>
<b>220403</b>	4.8	<b>£11.98</b>



Antex GASCAT60 gas soldering iron kit. Contains GASCAT60 iron (220401) plus hot air tip, flame tip, hot knife tip and sponge in plastic case.

**220404**

**£74.31**



Antex soldering iron bench stand ST4. Made in the UK.

**220304**

**£9.06**



A good quality budget soldering iron bench stand with hollow base. Sponge included. Base Dimensions (H x W x D) 23 x 86 x 130mm. Spring holder Length: 100mm. Centre hole  $\varnothing$ : 23mm. Inner cup size  $\varnothing$ : 32mm. Suitable for soldering irons 220305 & 220306 - p.237 & 238.

**220311**

**£4.11**



"Fluxite" soldering paste. Contains zinc and ammonium chlorides in petroleum grease. 100g tin.

**220201**

**£19.33**



Tube of multicore 5-core general purpose solder. 40/60 tin/lead alloy. 1.2mm diameter. Ideal for electrical and general purpose soldering. Self-fluxing. Extra active non corrosive flux. Approx 1.8m.

**220103**

**£6.02**



60/40 fluxed core solder (60% tin, 40% lead). 18 swg (1.2mm diameter). 500g roll.

**220101**

**£31.88**



Solder sucker. Aluminium pump with teflon tip.

**220501**

**£9.68**

## TESTING



Chrome plated brass circuit tester, for voltage testing on 6V, 12V and 24V systems. Comes with removable screw on probe protecting cap.

**240103**

**£8.73**



Induction ammeter. 30-0-30 Amps. Indicates approximate current and direction when clipped to cables. 57mm dia.

**240104**

**£28.52**

## JUMP LEADS



A top quality set of flexible and easy to use 5 metre jump leads. Produced using 16mm<sup>2</sup> high grade multi-strand copper conductors and is sheathed with a supple PVC. These jump leads are rated to a continuous rating of 110 Amps & a peak rating of 400 Amps. They are fitted with strong heavy-duty crocodile clips which are fully insulated. Supplied in a carry bag with instructions for use. Suitable for use with the following:

Petrol vehicles: up to 2500cc  
Diesel engines: up to 2000cc

**072501**

**£46.79**

## CHARGING



AccuMate- 6V & 12V battery optimiser. Suitable for all lead-acid batteries from 4 to 75 Amp-hours. SAE connection. Designed to automatically charge and monitor batteries with no danger of over-charging regardless of time. Perfect for owners of vehicles which are not used on a daily basis like classic and sports cars. 2 year warranty.

**210107**

**£63.56**



As above but with EU plug (210107-EU).

**210107-EU**

**£63.56**



Special accessory plug lead for use with SAE AccuMates (above) allowing connection to standard car cigarette lighter sockets and also to DIN sockets by removing the detachable red sleeve. **Note – before ordering, please check that your cigarette lighter is live when the ignition is OFF. The accessory plug lead is wired for NEGATIVE EARTH vehicles.**

**210105**

**£15.58**



The 12V/24V AccuMate PRO is a versatile automatic compact battery charger for lead-acid starter and deep cycle batteries of minimum capacity 17Ah (12V) or 9Ah (24V). Suitable for all types of lead/acid batteries. Ideal for long term maintenance of the batteries of irregularly or seasonally used vehicles & appliances, classic, veteran & collectors' vehicles. Interactive standby feature. No risk of overcharging. Detachable handle for carrying or wall-mounting. Dimensions of 14 x 16 x 15 cm (5½" x 6¾" x 6"high) including handle. Integral cooling fan. Intelligent electronic protections against inverse polarity, short-circuit, over-heating with built in spark suppression. Delivered with wall/carry bracket; mains lead; 2 detachable connection sets: one with battery clips, the other with eyelets for permanent attachment to the battery terminals, complete with an inline fuse. 24 months warranty excluding cables, connectors, sensors & probes. CE Certification.

**210109**

**£121.71**

## CHARGING (contd)



The AccuMate PRO 12V 4A is a versatile automatic compact battery charger for lead-acid starter and deep cycle batteries of minimum capacity 13Ah. Suitable for all types of lead/acid batteries. Ideal for long term maintenance of the batteries of irregularly or seasonally used vehicles & appliances, classic, veteran & collectors' vehicles. Interactive standby feature. No risk of overcharging. Detachable handle for carrying or wall-mounting. Dimensions of 14 x 16 x 15 cm (5½" x 6¾" x 6" high) including handle. Internal temperature monitor. Intelligent electronic protections. AC input fuse; and a thermal fuse protects the transformer. 2 detachable connection sets: one with battery clips, the other with eyelets for permanent attachment to the battery terminals, complete with an inline fuse. Can be connected directly to the vehicle lighter socket using 210108 (below). 24 months warranty.

**210106**

**£80.88**



Special accessory plug lead for use with white TM AccuMates (210106 & 210109) allowing connection to standard car cigarette lighter sockets and also to DIN sockets by removing the detachable red sleeve. **Note – before ordering, please check that your cigarette lighter is live when the ignition is OFF. The accessory plug lead is wired for NEGATIVE EARTH vehicles.**

**210108**

**£12.92**



This lead is useful if you have more than one vehicle that you wish to use your Accumate charger on. Connect the ring terminals to the battery and tuck the black SAE connector out of the way until you need to use the Accumate, when it can then just be plugged in. If several vehicles have one of these connecting leads, then the Accumate can be easily moved between vehicles to keep them topped up!

**210104**

**£8.93**

## INDEX

Battery Accessories	84	Junior Power Timer Connectors	69
Battery Boxes	85	Jump Leads	240
Battery Clamps & Covers	85 - 86	Lamp Spares	205 - 207
Battery Conditioners	241 - 243	Lamps - Dashboard Warning	209 - 211
Battery Isolator Switches	97 - 99	Lamps - Headlamps & Parts	182 - 187
Battery Terminals & Covers	90 - 95	Lamps - Indicator	188 - 192
Buckle Clips	28	Lamps - Interior	203
Bulbs & Bulb Holders	163 - 181	Lamps - Multifunction	204
Bullets & Bullet Connectors	52 - 54	Lamps - Number Plate	201 - 202
Busbars	102	Lamps - Rear & Rear Fog	196 - 200
Buzzers	216	Lamps - Reversing	200
Cable - Battery	20 - 21	Lamps - Side	192 - 196
Cable - Braided	10 - 12	P-Clips & P-Clip Kits	32 - 35
Cable - Ignition Lead/HT	17 - 19	Power Connectors	92
Cable - Multicore	14 - 16	Reflectors	208
Cable - Standard PVC	2 - 5	Regulators	224 - 226
Cable - Thin Wall	6 - 9	Relays, Relay Boxes & Sockets	129 - 138
Cable - Tinned Copper	13 - 14, 21	Rheostats	126
Cable - Trailer/Speaker	16	Saddle Clips/Self-Adhesive Clips	37 - 38
Cable Bundles	5, 9	Sleeving	22 - 26
Cable Fixing	28 - 38	Soldering	237 - 239
Cable Markers	27 - 28	Spark Plug Caps	75
Cable Ties & Mounts	29 - 31	Spark Plug Terminals & Covers	73
Chassis Clips	36 - 38	Starter Switches/Solenoids	101
Cigar Lighters	212	Switch Mounts & Panel Assemblies	108
Circuit Breakers	161 - 162	Switches - Brake Light	126 - 128
Condensors	83	Switches - Dip	123
Connectors	63 - 72	Switches - Door	118
DIN Sockets & Plug	214 - 215	Switches - Hazard	117
Diodes	215	Switches - Indicator	112 - 115
Distributor/Coil Acorns	82	Switches - Key	120 - 123
Distributor Terminals & Covers	76 - 77	Switches - Push Button	110 - 112
Dynamos, Pulleys, Fans & Brushes	221 - 223	Switches - Push/Pull	109
Earth/Bonding Straps & Braid	96	Switches - Rocker	124 - 125
Fans	221	Switches - Rotary	118 - 119
Flasher Units	139 - 142	Switches - Toggle	103 - 107
Fuel Pumps	218	Tape	42 - 44
Fuse Boxes	143 - 145	Terminals - Heat-Shrink	61 - 62
Fuses & Fuse Holders	146 - 160	Terminals - Insulated	55 - 60
Grommets/Grommet Strip	39 - 41	Terminals - Non-Insulated	45 - 53
Headlamp Harnesses	188	Testing Equipment	240
Heatshrink Sleeving	23	Tools	235 - 239
Horns	217	Towing Accessories	228 - 232
Ignition Coils	78 - 82	USB Sockets & Adapters	213 - 214
Indicator/Hazard Kits	115 - 116	Voltage Stabilisers	216
Junction Boxes	211	Washer Pumps & Bottles	219 - 220



[www.wosperformance.co.uk](http://www.wosperformance.co.uk)

## Alternators Starter Motors Dynators



### BESPOKE STARTING AND CHARGING SYSTEMS

Supplying OE based units to the classic, vintage, race and bespoke car market for over 30 years catering for vehicles from 1908-2022 and race series including WRC, WEC, WTCC and Le Mans.

**O.E. QUALITY. NO COMPROMISE.**

**Who's starting & charging you?**